



2013 Mustang Rear Valance Kit

P/N: 421406 (R1313-17F957)

Application: 2013 Ford Mustang

Note: Roush rear valance kit will only work with the Roush off road exhaust system
P/N: 1313-5231.

Installation Instructions

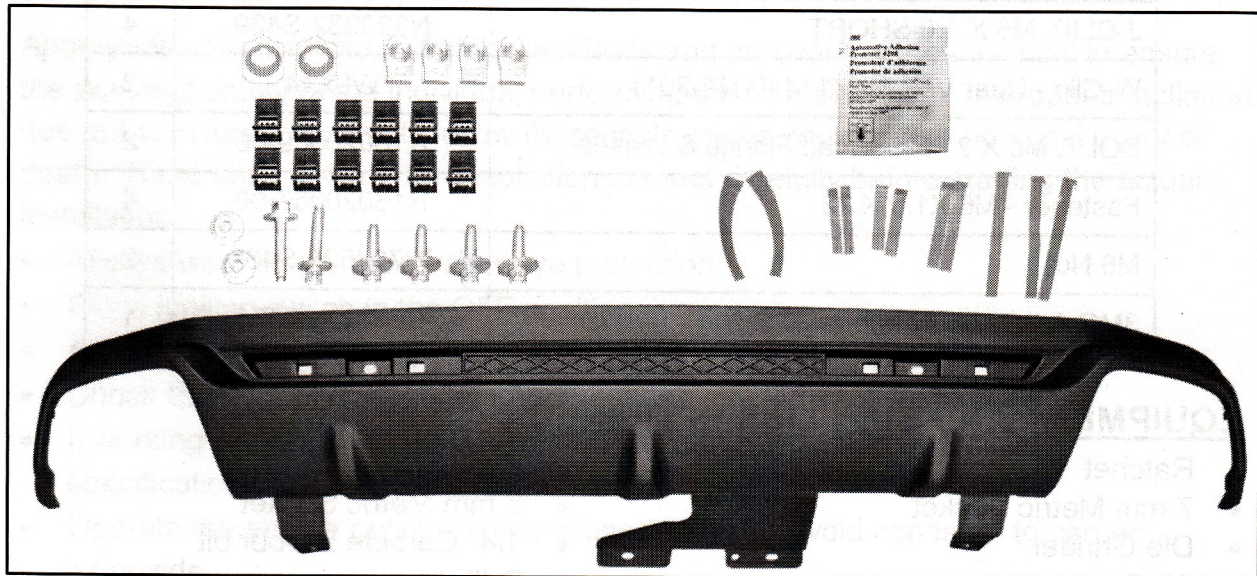

Before installing your ROUSH Performance Product(s), read through the entire installation procedure and check to make sure all items are present. Contact ROUSH Customer Service at 1-800-59-ROUSH, weekdays from 9:00 AM to 5:00 PM EST, with any questions regarding fit, missing parts or instructions that are unclear to you.

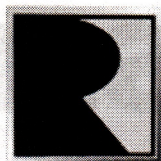

ROUSH

PERFORMANCE

Description	Part Number	Qty
2013 Mustang Rear Bumper Cover Valance Kit	R1313-17F957	1
Rear Bumper Valance	1313-17F957	1
Rear Valance Tape Kit	1313-17F957TAPE	1
Rear Valance Template	1313-17F958TMPL	1
Installation Manual	1313-17F957IM	1
Rear Valance Hardware Kit	1313-17F957HK	1
U-NUT #10 X 20MM Wide x 31 MM LONG	19339B	12
J-CLIP, M6 X 1.0 SHORT	N623332-S439	4
W-Clip - Rear Valance (11440-NT-201)	W9X14	2
BOLT, M6 X 31 Hex Head Flange & Washer	R18020009-00	2
Fastener - M6 X1.0 X 22	R18020057-00	4
M6 Nut	W704521-S437	2
3M® Adhesion Promoter	021200-27571	1

EQUIPMENT AND SUPPLIES REQUIRED

- Ratchet
- 7 mm Metric Socket
- Die Grinder
- Air Saw
- 1/8" Drill Bit
- 1/4" Drill Bit
- 9/16" Drill Bit
- Torque Wrench
- Safety Glasses
- 8 mm Metric Socket
- 1/4" Carbide De-bur bit
- Drill
- Center Punch
- 3/8" Drill Bit
- 10 mm Wrench
- Commercially Available Clear Coat

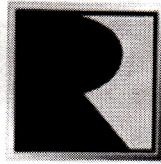

ROUSH[®]
P E R F O R M A N C E

LIMIT OF LIABILITY STATEMENT

The information contained in this publication was accurate and in effect at the time the publication was approved for printing and is subject to change without notice or liability. ROUSH Performance Products (RPP) reserves the right to revise the information presented herein or to discontinue the production of parts described at any time.

SAFETY REQUIREMENTS

STOP! READ IMPORTANT SAFETY CAUTIONS AND WARNINGS BEFORE PROCEEDING.

IMPORTANT SAFETY NOTICE

Appropriate disassembly, assembly methods and procedures are essential to ensure the personal safety of the individual performing the kit installation. Improper installation due to the failure to correctly follow these instructions could cause personal injury or death. Read each step of the installation manual carefully before starting the actual installation.

- Always wear safety glasses for eye protection.
- Place ignition switch in the OFF position.
- Always apply the parking brake when working on a vehicle.
- Chock the front and rear tires to prevent unexpected vehicle movement.
- If working without a lift, always consult vehicle manual for correct lifting specifications.
- Operate the engine only in well-ventilated areas to avoid exposure to carbon monoxide.
- Do not smoke or use flammable items near or around the fuel system.
- Use chemicals and cleaners in well-ventilated areas.
- Batteries produce explosive gases, which can cause personal injury. Therefore, do not allow flames, sparks or flammable substances to come near the battery.
- Keep hands and any other objects away from the radiator fan blades.
- Keep yourself and your clothing away from moving parts when the engine is running.

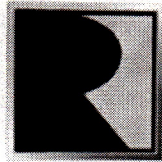

ROUSH®
P E R F O R M A N C E

- Do not wear loose clothing or jewelry that can get caught in rotating parts or scratch surface finishes.
- Allow the engine, cooling system, brakes and exhaust to cool before working on a vehicle.

WORK SAFELY!

Perform this installation on a good clean level surface for maximum safety and with the engine turned off.



SECTION A – Removal

The following section will guide you through the removal of the factory bumper cover.

1. Open the trunk and remove the two (2) plastic nuts, two (2) pin-type retainers, release the trunk trim panel, disconnect the trunk light electrical connector and remove the trunk trim panel.

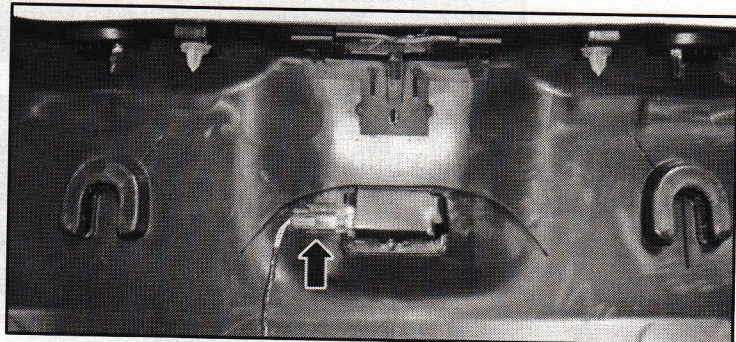
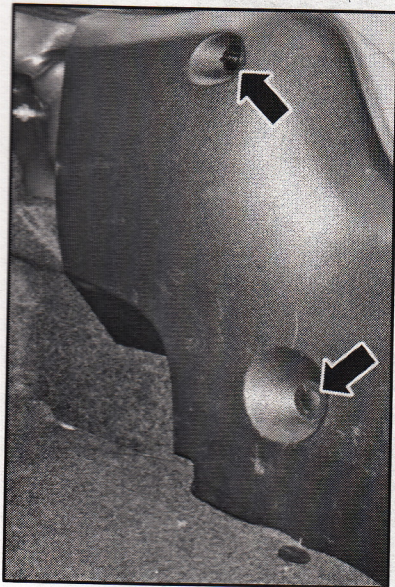



ROUSH[®]
P E R F O R M A N C E

2. Release the side marker harness retainer.

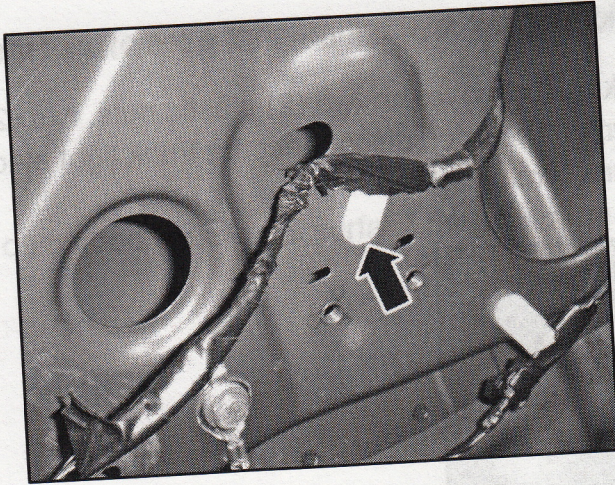

3. Disconnect the LH and RH tail lamp electrical connectors.



4. Remove the six (6) 11 mm nuts, push the harness grommets through the body and remove the LH and RH tail lamps.

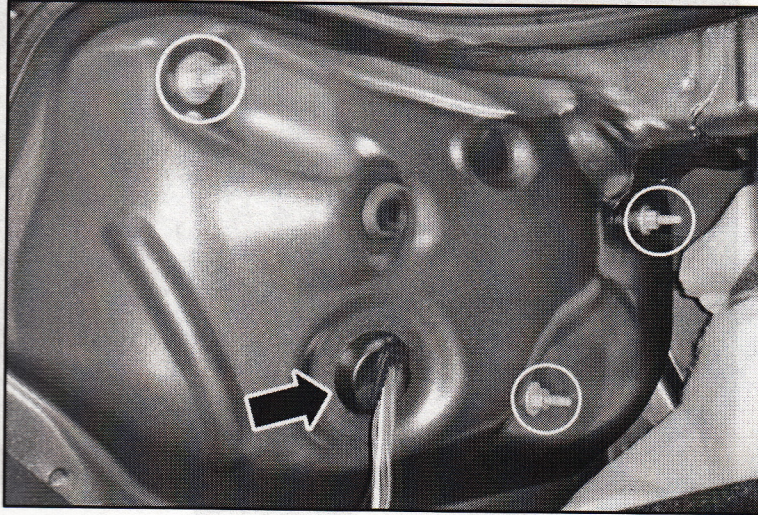

5. Remove the six (6) screws and depress the two (2) center clips on the LH and RH side splash shields to release.

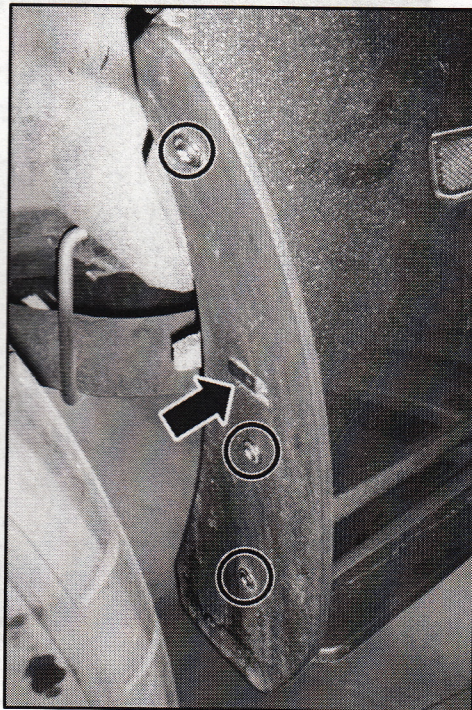



ROUSH[®]
P E R F O R M A N C E

6. On the underside of the vehicle, remove and discard the two (2) clips.

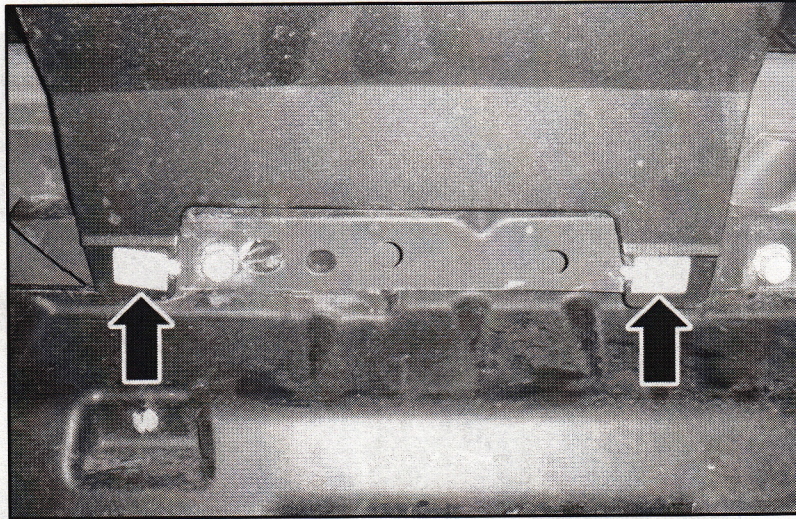

7. Remove the four (4) pin-type retainers.

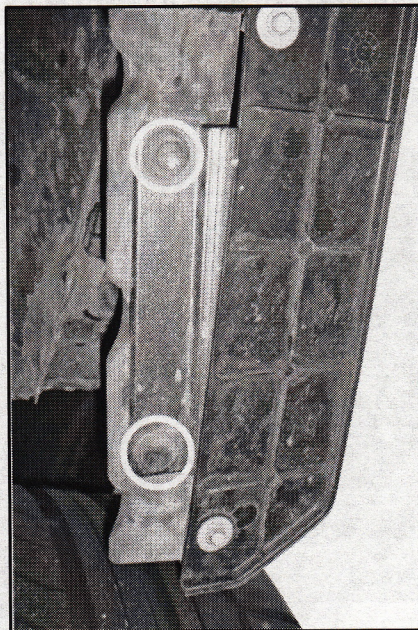



ROUSH[®]
P E R F O R M A N C E

8. Remove the two (2) pin-type retainers.

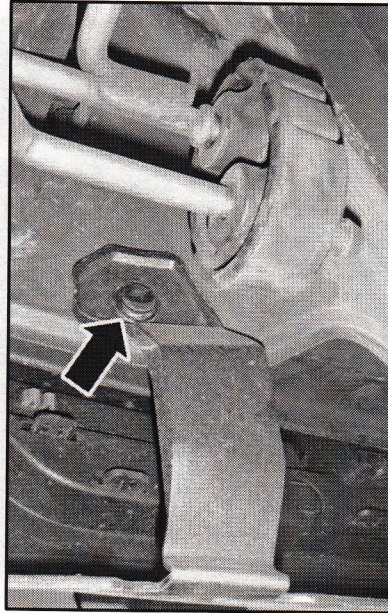

CAUTION: To protect the bottom of the bumper cover from damage, place on a protective surface once removed.

9. Pull outward on the LH and RH side to release the bumper cover, holding the center remove the bumper cover.

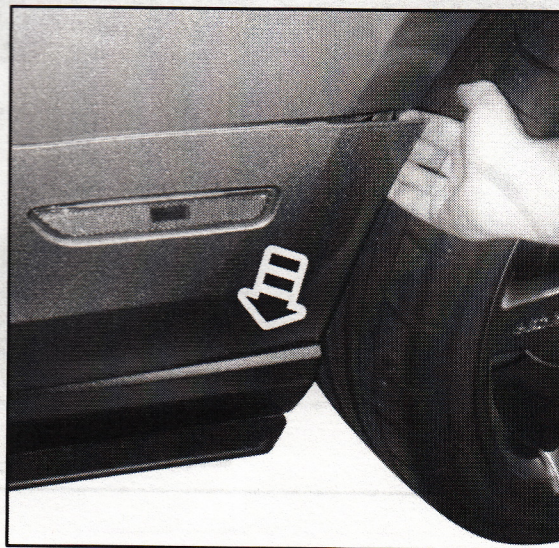



10. Remove the two (2) reflectors and the center trim piece; depress the four (4) reflector marker tabs and fourteen (14) center trim tabs.

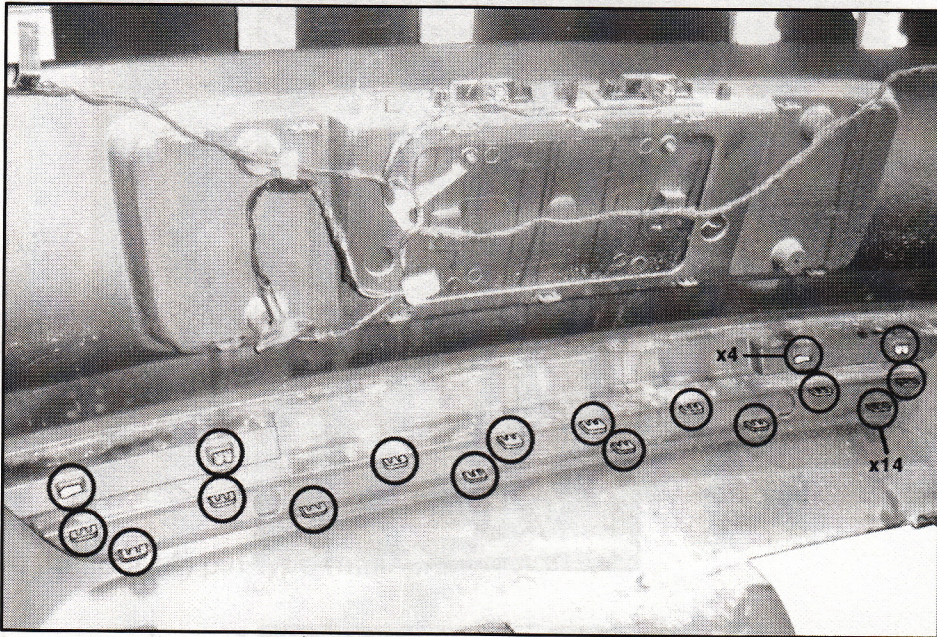

11. Cut out the exhaust area templates provided in the kit (P/N: 1313-17F958TMPL), tape the template to the bumper cover and mark the area as shown.

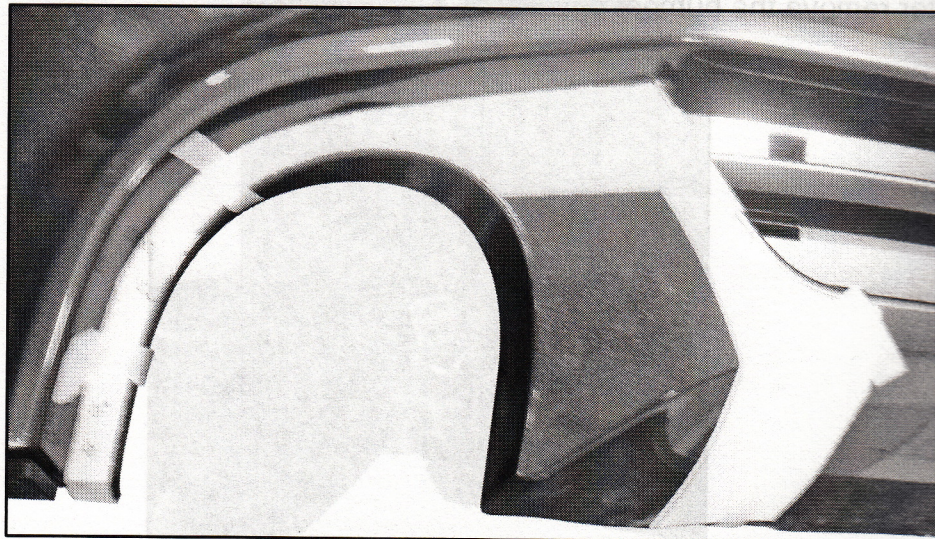

12. Using a center punch, mark the center of the holes on the template.

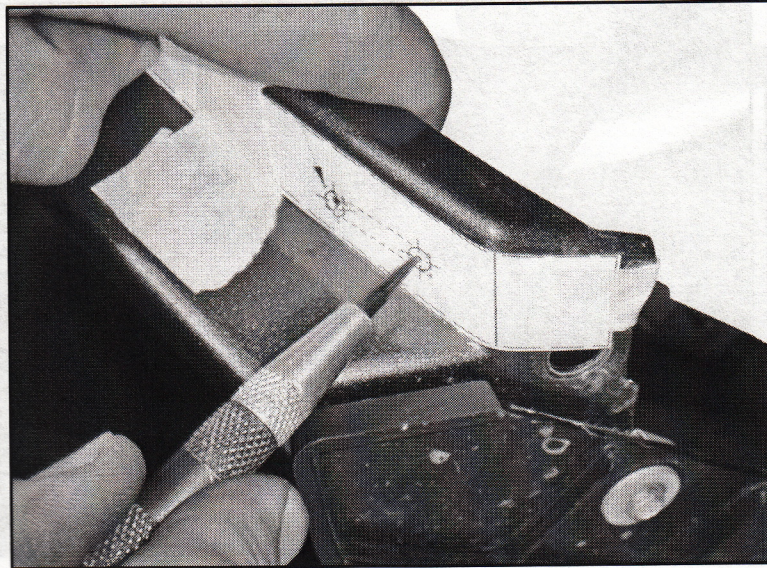

13. Remove the template, use a 1/8" drill bit to drill the pilot holes and finish with a 1/4" drill bit.

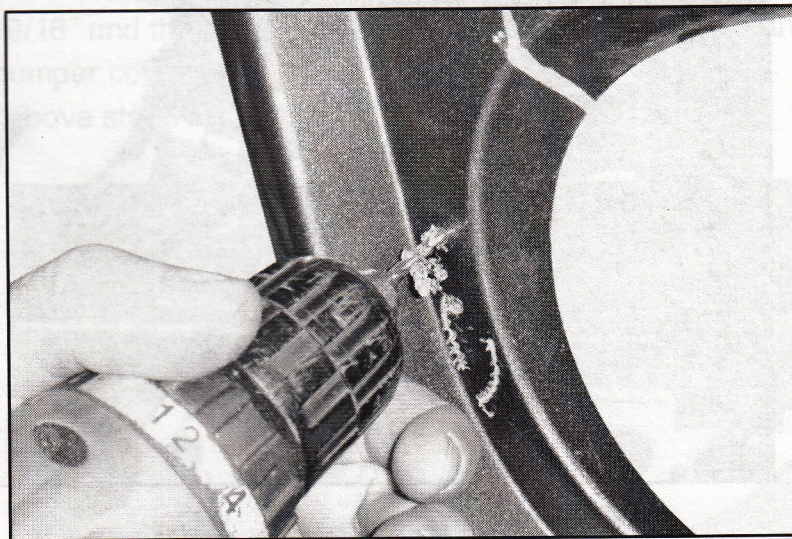

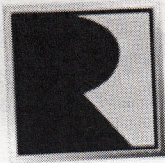

ROUSH
P E R F O R M A N C E

14. Mark the lines to be slotted on the bumper cover.

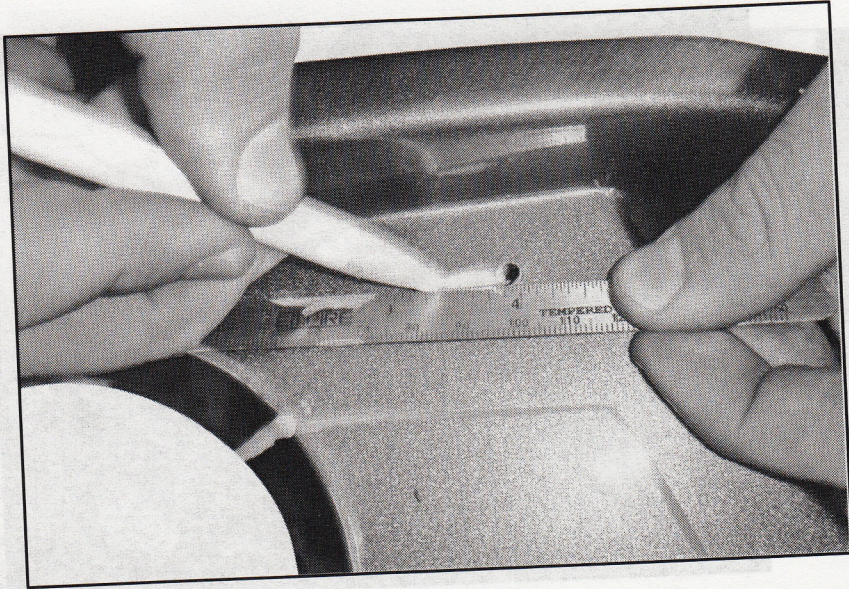

15. Using a 1/4" de-burring tool, open the slots marked on the bumper.

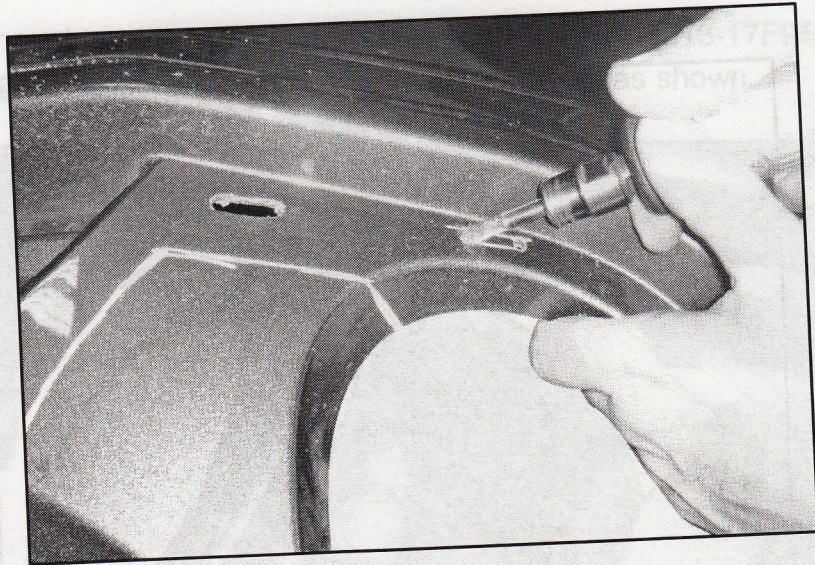



16. Cut off the area marked on the bumper cover and repeat steps 11-16 for the opposite side.

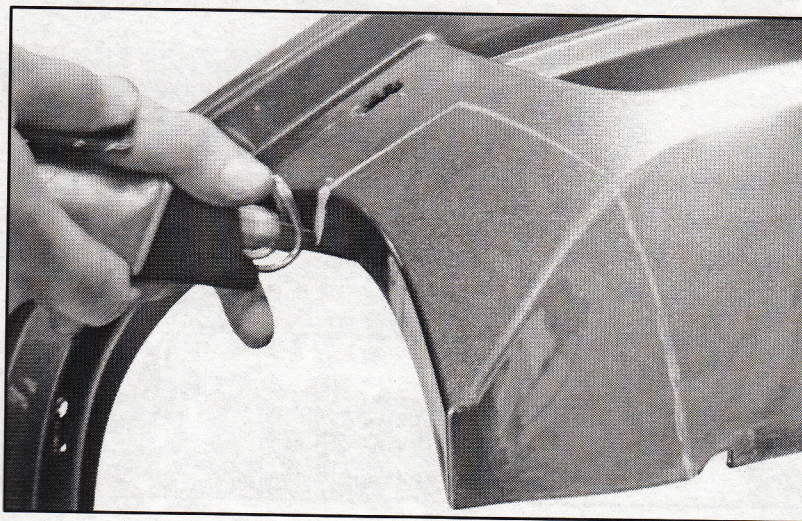

17. Cut out the locator/U-Nut template provided in the kit (P/N: 1313-17F958TMPL), tape the template to the bumper cover.

- Using a center punch, mark the the center of the holes on the template.
- Cut the 9/16" and the 3/8" holes out of the template and trace the holes to cut on the bumper cover.
- Repeat above steps for the opposite side.

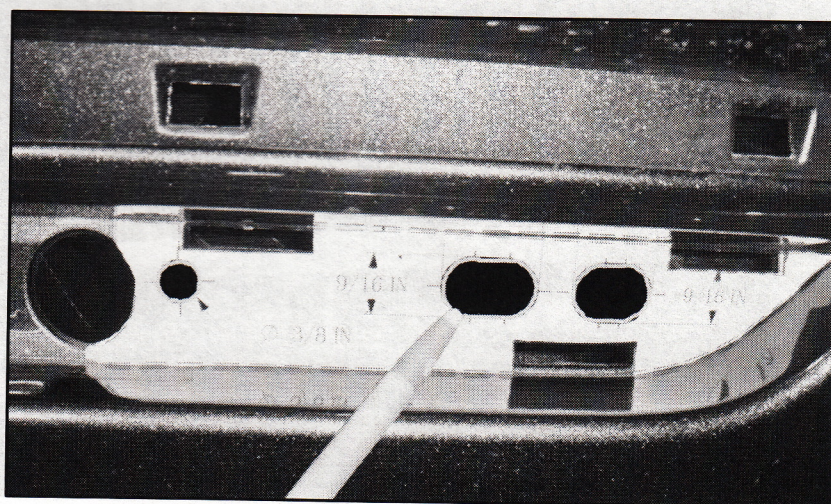



ROUSH
PERFORMANCE

18. Drill the pilot holes using a 1/8" drill bit. Drill the 3/8" hole opening using a 3/8" drill bit and slot the 9/16" holes openings using a 9/16" drill bit.
- Repeat above step for the opposite side.

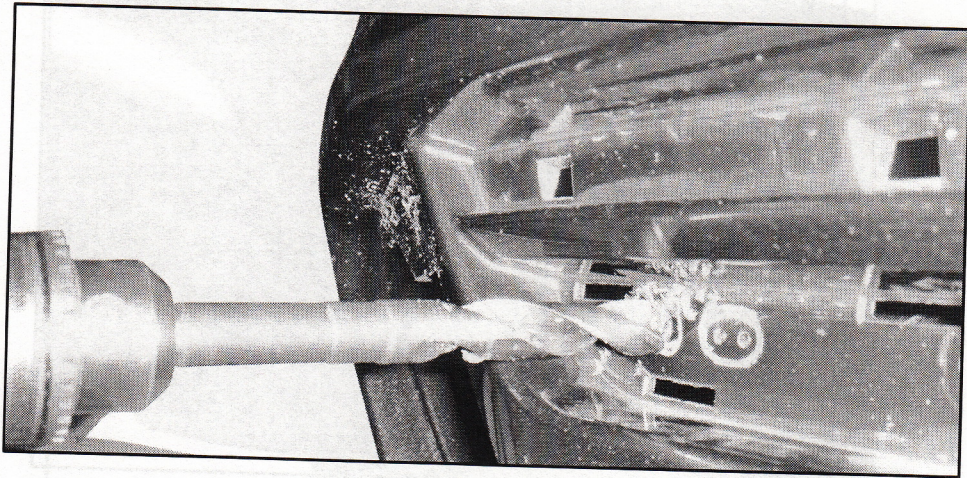

NOTE: The bottom edge of the template must be flush with the surface edge of the bumper cover.

19. Cut out the center template provided for the valance panel and tape into position with the arrow pointing upward.
- Using a center punch, mark the the center of the holes on the template.





20. Using a 1/8" drill bit, drill the pilot holes and finish with a 1/4" drill bit.

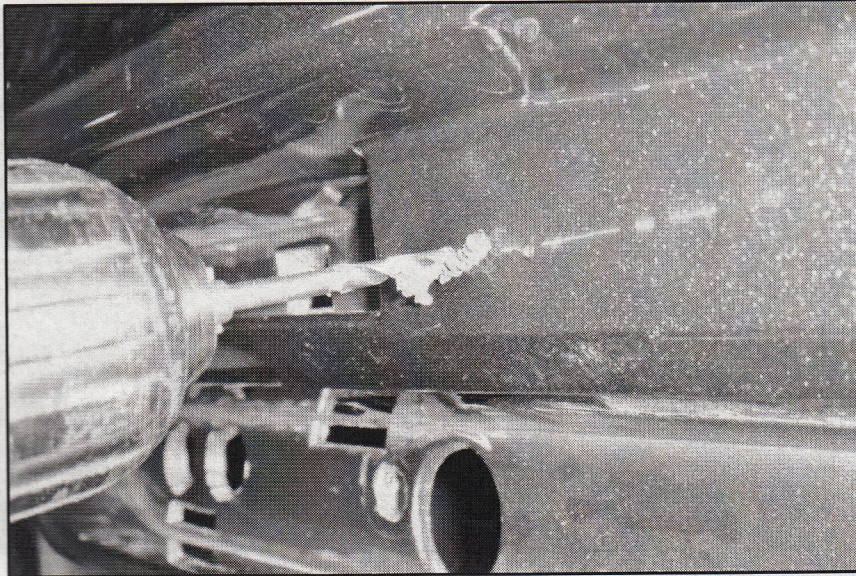

21. Mark the lines to be slotted on the bumper cover.

- Using a 1/4" de-burring tool, open the slots marked on the bumper.

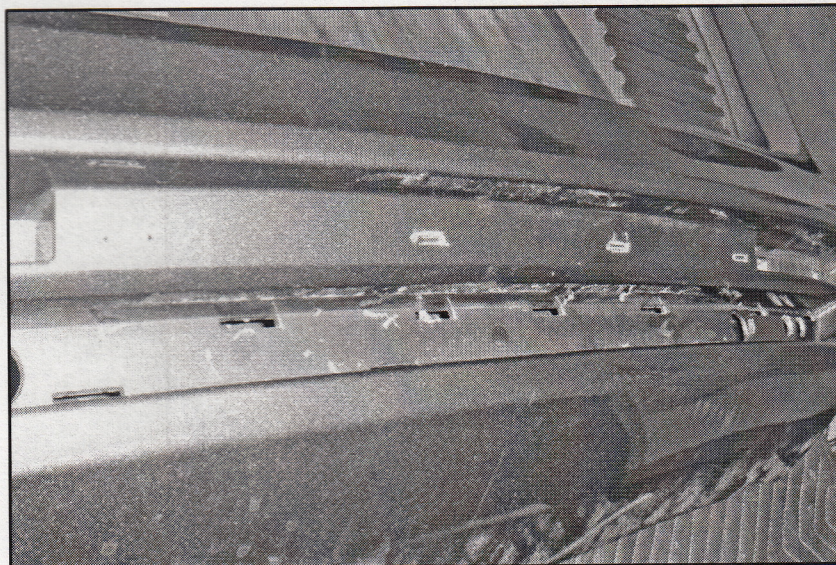



ROUSH
P E R F O R M A N C E

22. Install the two (2) J-clips (P/N: N623332-S439) in the holes on the bumper cover.

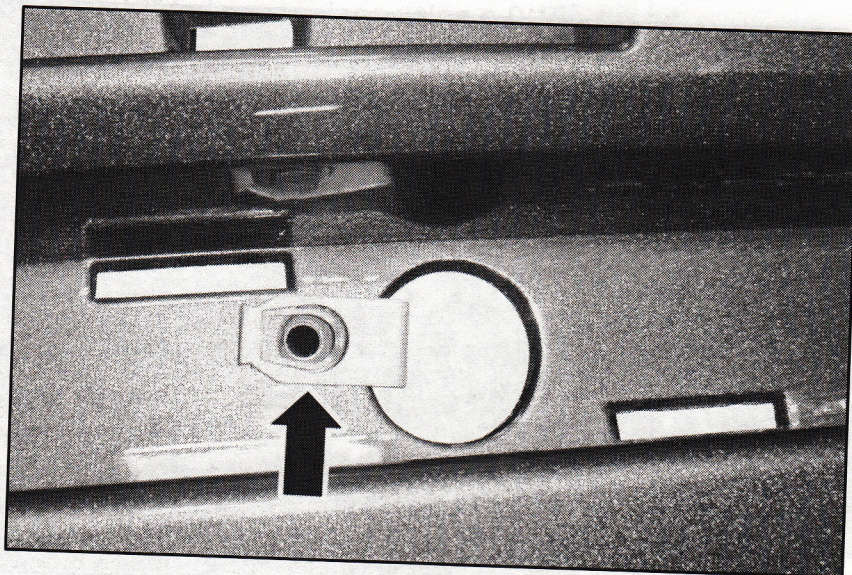

23. Cut out the template for lower LH and RH bumper cover mounts.

- Using a center punch, mark the center of the holes on the templates for the LH and RH bumper cover mounts.

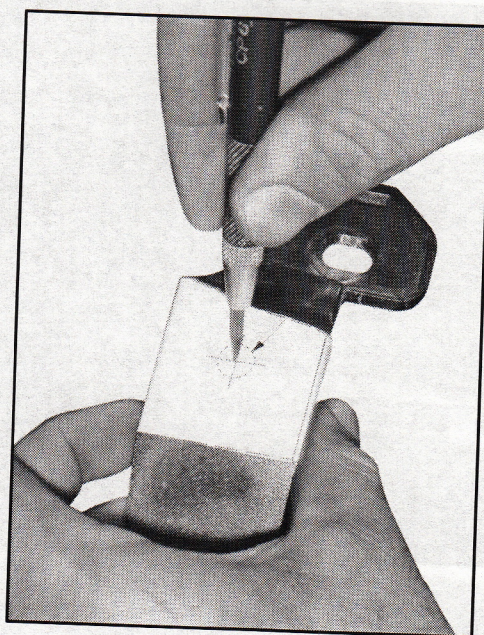



24. Drill the pilot holes using a 1/8" drill bit and finish opening the holes with a 3/8" drill bits on the LH and RH bumper cover mounts.

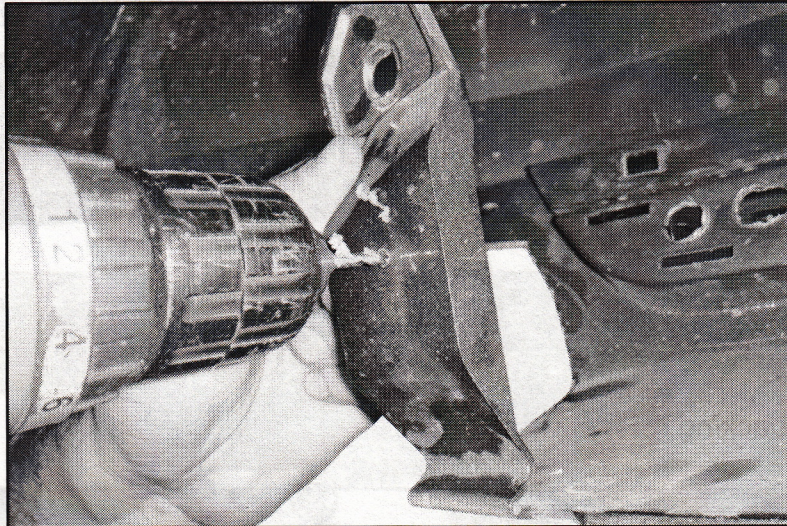

25. Using alcohol, clean the rear valance and bumper cover mating surfaces. Apply 3M Ad-Pro® (P/N: 021200-27571) to the rear valance where tape will be applied.

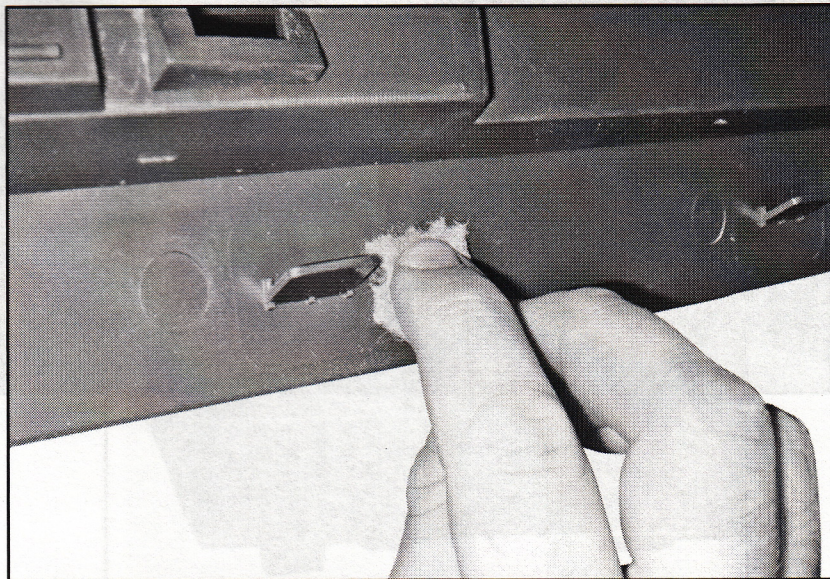



ROUSH[®]
P E R F O R M A N C E

26. Install the 2-sided tape (P/N: 1313-17F957TAPE) on the back side of the rear valance as shown.

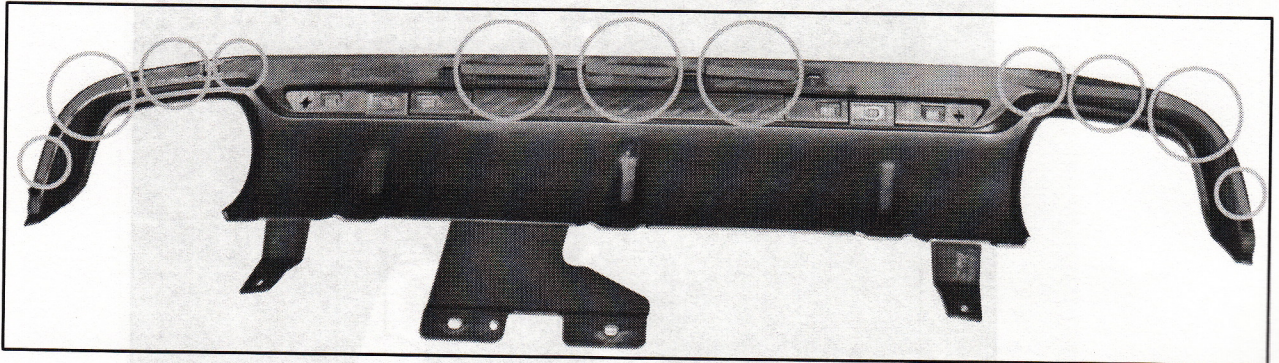

27. Peel the backing off the 2-sided tape.

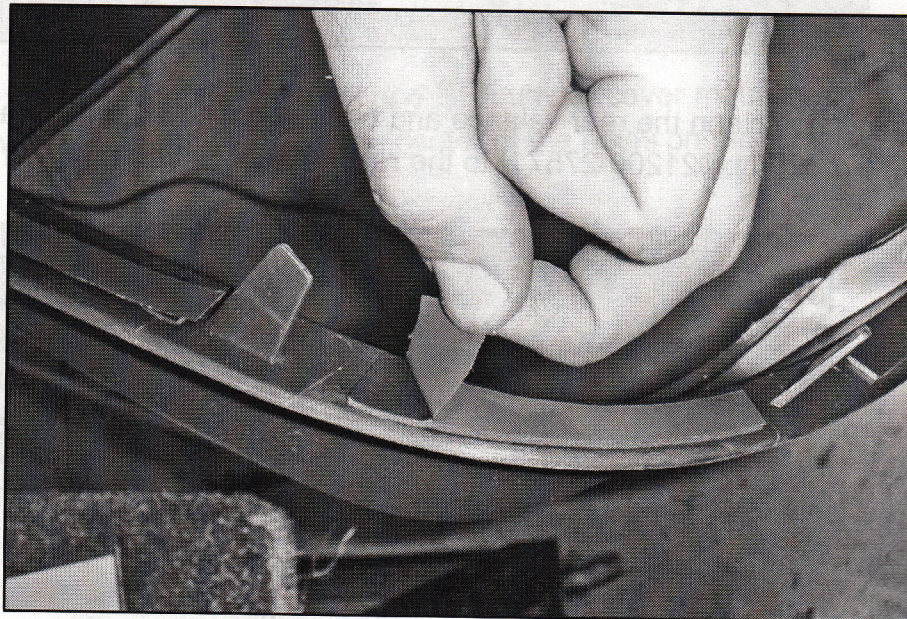



28. Place the rear valance (P/N: 1313-17F957) on the bumper cover.
29. Install the twelve (12) U-nuts (P/N: 19339B), two (2) W-clips (P/N: W9X14) and two (2) 8 mm bolts (P/N: R18020057-00) on the back of the valance.

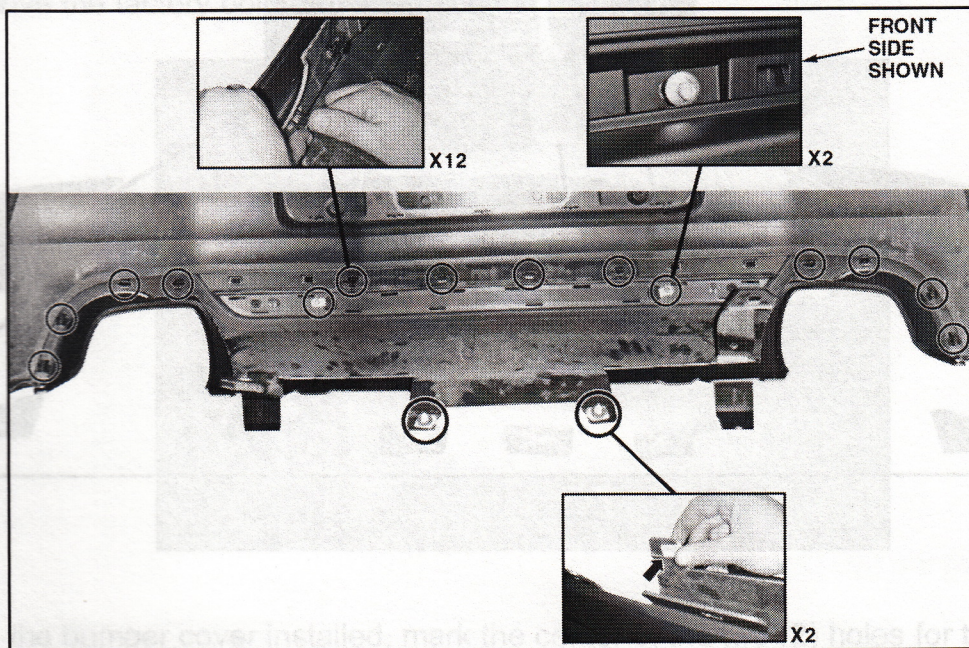

30. Reinstall the two (2) reflector markers.



NOTE: After drilling the holes, apply commercially available clear coat such as Motorcraft® (P/N: PM-19500-600) to the bare metal surfaces.

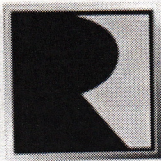

ROUSH[®]
P E R F O R M A N C E

31. Remove sections of the foam bumper cover insert shown for proper fit.

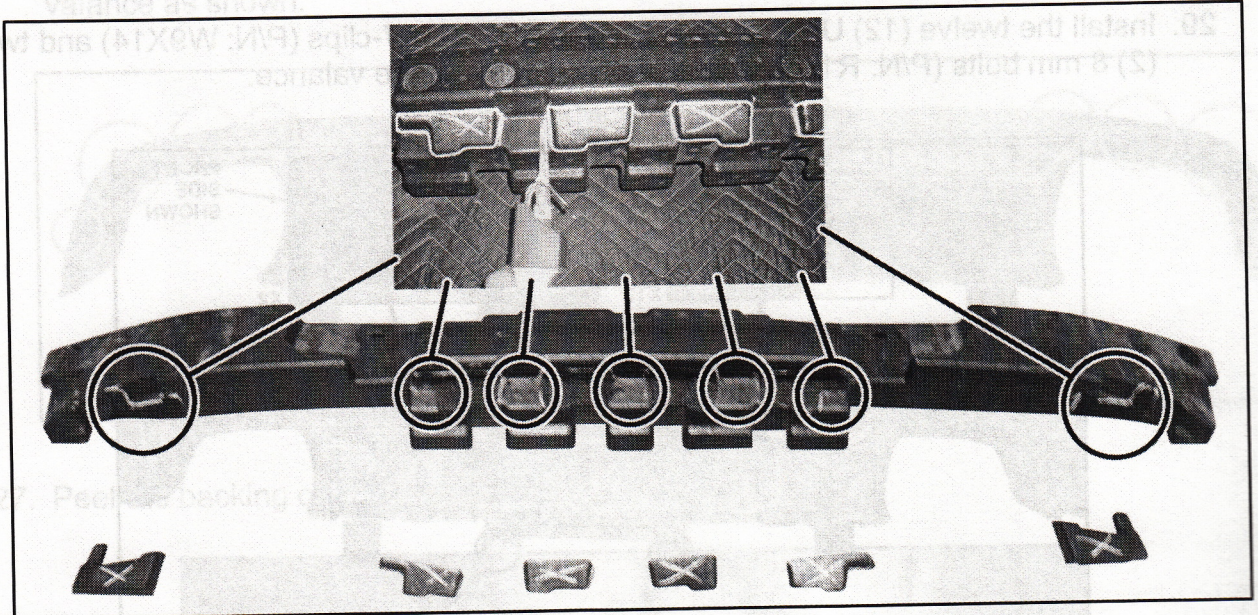



SECTION B – Installation

1. To install the bumper cover, reverse the removal steps 1-9.
2. Remove the factory bolt from the mounting bracket.

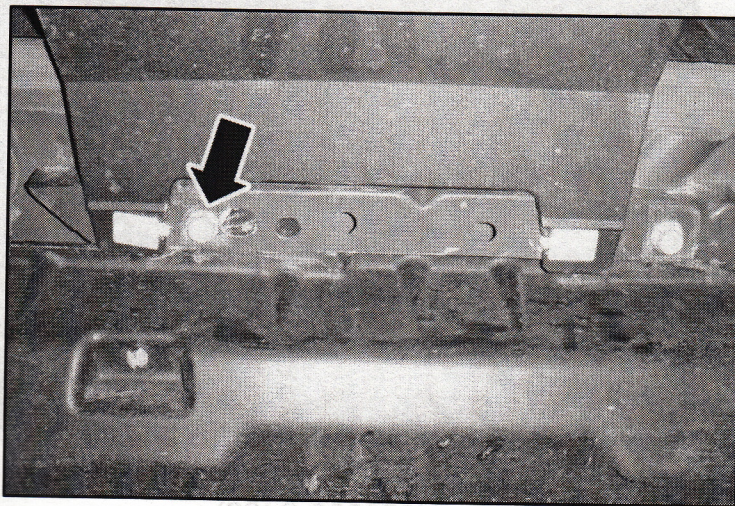

3. With the bumper cover installed, mark the center of the two (2) holes for the center bumper cover mount.

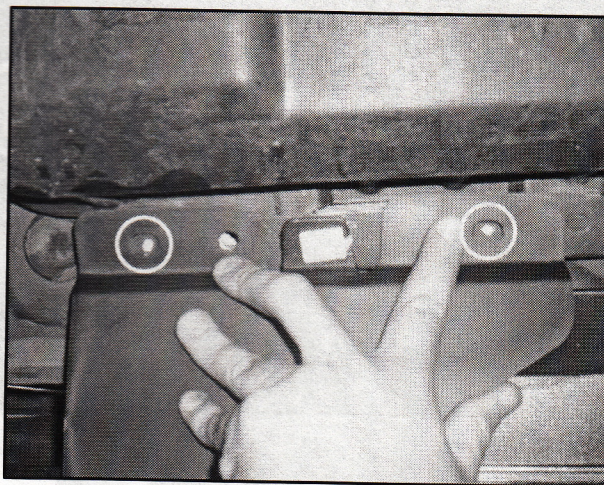

NOTE: After drilling the holes, apply commercially available clear coat such as Motorcraft® (P/N: PM-19500-600) to the bare metal surfaces.



4. Drill two (2) 1/8" pilot holes. Open with a 1/4" drill bit on the center bumper cover bracket.

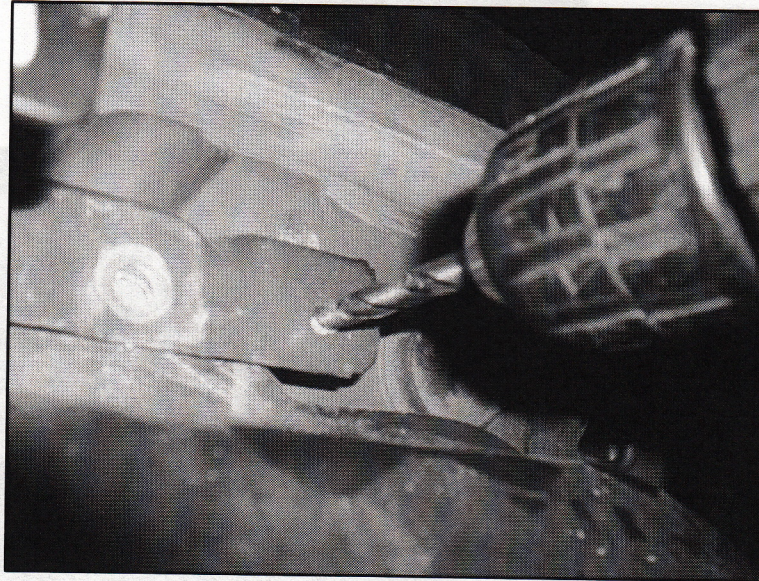

5. Install the two (2) J-clips (P/N: N623332-S439).

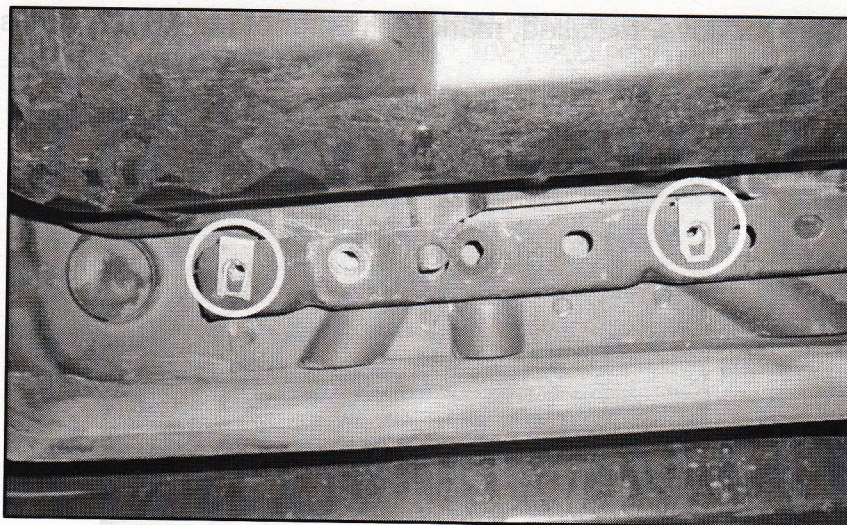

NOTE: After drilling the holes, apply commercially available clear coat such as Motorcraft® (P/N: PM-19500-600) to the bare metal surfaces.



6. Install the two (2) 8 mm bolts (P/N: R18020057-00) and one (1) factory bolt removed in step 3.
- Tighten to 6 Nm (53 lb-in).

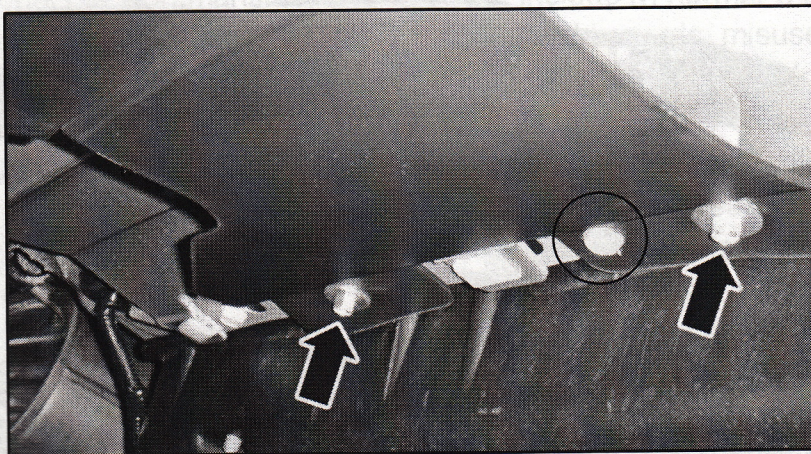

7. Install the two (2) push-pins, two (2) 8 mm bolts and two (2) nuts (P/N: W704521-S437) through lower LH and RH bumper cover mount.
- Tighten to 6 Nm (53 lb-in).

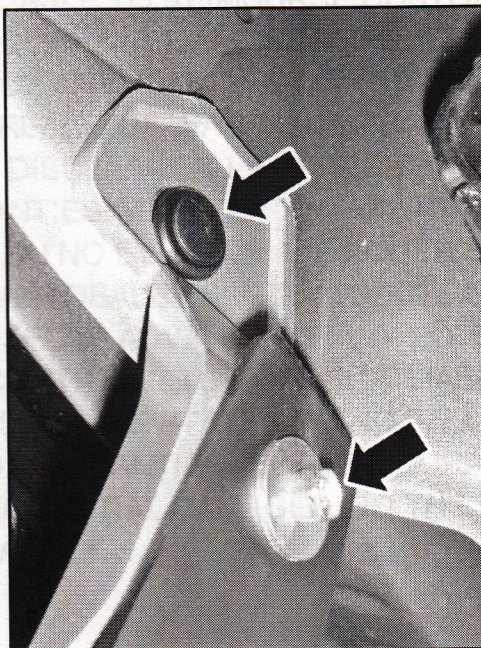



Congratulations!!! You have completed the installation of your new ROUSH Performance Products 2013 Mustang rear valance kit.



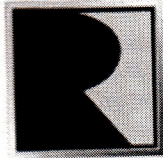

ROUSH[®]
P E R F O R M A N C E

WARRANTY

All retail parts carry a 90-day warranty from the date of purchase. This warranty covers defects in materials or workmanship, and does not include (i) normal wear and tear, environmental conditions, improper installation; (ii) road hazards, misuse, abuse, neglect, accidents, collision, fire, theft, freezing, vandalism, riot, explosion, or objects striking the vehicle; (iii) misusing the vehicle, such as driving over curbs, overloading, racing or using the vehicle as a stationary power source; (iv) altering, disassembling or modifying the parts; (v) defects caused or induced by failures, breakdowns or damage by other parts, components or the vehicle; (vi) subjecting the parts to excessive moisture or water or any motor vehicle fluids (e.g.: oil, anti-freeze, battery acid, brake fluid, etc.); (vii) acts of God, natural disasters and other similar causes beyond the reasonable control of ROUSH; or (viii) application of chemicals that affect the parts. This Limited Warranty does not cover surface deterioration of paint, trim and appearance items that result from use and/or exposure to the elements, such as stone chips, scratches, bird droppings, lightning, hail, windstorm, dings, dents, earthquake, road salt, tree sap, water or flood.

ROUSH SHALL NOT BE LIABLE TO REIMBURSE CUSTOMER/DEALER FOR INCIDENTAL OR CONSEQUENTIAL DAMAGES RESULTING FROM THE INSTALLATION OR USE OF ANY PRODUCT SOLD THROUGH THIS CATALOG OR ARISING OUT OF ANY BREACH OF WARRANTY. EXCEPT AS MAY BE STATED IN THIS CATALOG, ROUSH DISCLAIMS ALL EXPRESS AND IMPLIED WARRANTIES, INCLUDING THE WARRANTIES OF MERCHANTABILITY AND FITNESS FOR A PARTICULAR PURPOSE. IN NO EVENT SHALL ROUSH'S LIABILITY EXCEED THE PRICE PAID BY CUSTOMER/DEALER FOR PRODUCTS SOLD REGARDLESS IF ROUSH HAS BEEN ADVISED IN ADVANCE OF ANY POTENTIAL PROBLEM OR IF A CLAIM IS BASED ON CONTRACT, TORT, STRICT LIABILITY, PRODUCT LIABILITY OR OTHERWISE. SOME STATES DO NOT ALLOW THE EXCLUSION OR LIMITATION OF IMPLIED WARRANTIES OR THEIR DURATION, OR LIABILITY FOR INCIDENTAL OR CONSEQUENTIAL DAMAGES, SO THE ABOVE EXCLUSIONS OR LIMITATIONS MAY NOT APPLY.