

**PART # 1166,1170,1171,1172,1174,1175,1176, 1178 & 1182****05-09 MUSTANG HOODS**

**Notice: Prefit Before Painting!  
Painted or Altered Parts are Non-Refundable**

- STEP 1: Remove the striker bar from the factory hood and install it with Locktite® to your new hood
- STEP 2: Adjust hood until proper alignment with matching panels is achieved.
- STEP 3: Adjust primary latch until the striker bar fits into the latch. Make sure when the hood is closed you can hear the striker bar “click” into the latch.
- STEP 4: After you here it click, test it to be sure it's working properly by grabbing the front edge of the hood and slowly pulling upward with a steady even pressure. If the hood opens it's not adjusted properly; repeat STEP 3 until hood cannot be pulled open after it's closed.

**WARNING: MAKE SURE THE SAFETY CATCH IS WORKING PROPERLY!**

- STEP 5: To ensure the safety catch is working properly, close the hood, pull the hood release from inside the car and the hood will partially open. Slowly pull upward on the hood and jiggle it at the same time. If it opens without pulling the safety catch lever then the latch needs to be readjusted. The safety catch prevents the hood from opening in the event the primary latch fails.

- STEP 6: Locate the hood stoppers  located on the radiator support. Adjust upward until they apply a small amount of pressure to the underside of the hood when it is closed. This will prevent the hood from shaking or rocking. Install squirters as shown in Fig. A. (You may need to bend the squirters into position.)

- STEP 7: After all adjustments have been made, apply loctite to the bolts that secure the latch bar to the hood. Reinstall the weather striping on the rear of the hood. You will need to cut it so that it does not cross over top of the squirters. Then run the squierter hose thorough the weather striping.

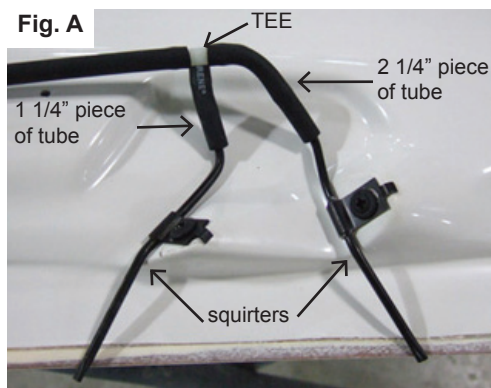

| PART #1171 |                           |             |
|------------|---------------------------|-------------|
| QTY        | DESCRIPTION               | HARDWARE #  |
| 2          | SCREEN                    | E           |
| 6          | FLAT-HEAD PHILLIPS SCREWS | 10947-01704 |
| 2          | SQUIRTERS                 | BER001      |
| 1          | TEE                       | WE2426      |
| 1          | 14" RUBBER TUBING         | 51075K24    |

| PART #1166,1170,1172,1174,1175,1176,1178 & 1182 |                           |             |
|---|---------------------------|-------------|
| QTY   | DESCRIPTION               | HARDWARE #  |
| 2   | FLAT-HEAD PHILLIPS SCREWS | 10947-01704 |
| 2   | SQUIRTERS                 | BER001      |
| 1   | TEE                       | WE2426      |
| 1   | 14" RUBBER TUBING         | 51075K24    |



## PART #4322

### 05-06 MUSTANG GRILLE & HEADLIGHT EXTENTIONS

**Notice:** Prefit Before Painting. Install new, unpainted parts according to these instructions. Then remove parts, paint them and re-install.

#### Painted or Altered Parts are Non-Refundable

The surface that is in contact with the 3M 2-sided tape must be cleaned with isopropyl alcohol & the temperature must be a minimum of 75 degrees F, before applying . Allow the 2-sided tape to dry 24 hours before driving.

**Pre-fitting the grille and the headlight extension:** If you have a GT use the template provided with these instructions to trim away the material needed for clearance around the fog lights. If you have a V-6 no trimming is required. Place the grille extension against the honeycomb of the factory grille and center it left to right. Open the hood and remove the top bolt that secures the front bumper to the radiator support along the inside of each headlight. Hold each head light extension in place and reinstall that top bolt. Place a piece of masking tape on the bumper, even with the front edge of the headlight extension and using a pencil, mark the tape in each front corner **as shown in fig. A**. This pencil mark is used as a reference for aligning the grille extension notch (**notch is shown in fig. B**). DO NOT REMOVE THIS TAPE.

**Optional screw mounts for the headlight extensions:** These headlight extensions have an optional screw mounting point. Follow the instructions on the template for mounting these screws.

**Step 1, installing the painted grille extension:** Included in the hardware packet is a roll of 3M, 2-sided tape. After the grille extension has been painted, install the 3M, 2-sided tape along the guideline 1/8" away from the outer edge **as shown in fig. C**. Then completely remove the red backing on the 2-sided tape that overlays the factory grille. Peel and fold about 2" of the red backing from the other piece of tape. Place the grille extension overtop of and touching the honeycomb portion of the factory grille and align the pencil mark even with the notch **as shown in fig. D**. This will allow you to get the best alignment of the part. While holding the extension in place pull the backing slowly, after all the backing is removed, firmly press the edges of the grille extension to securely adhere the tape.

**Step 2, installing the painted headlight extensions:** Included in the hardware packet is a roll of 3M, 2-sided tape. After the headlight extensions have been painted, install the 3m, 2-sided tape along the guidelines 1/8" away from the outer edge **as shown in fig. E**.

**Installing optional screw mounts for headlight extensions:** (If you are using the optional screws for mounting points then trim away some of the 2-sided tape **as shown in fig. F**. and refer to the instructions on the template page to finish this installation.)

**Step 2 continued:** Peel the red backing from each piece of tape, then attaching it to the fender aligning the extension with the hood edge first, then down the fender, across the bumper, and up along the inside of the headlight. Press the edges down firmly and install the factory bolt on top.

### PAINTING INSTRUCTIONS

**VERY IMPORTANT: The following painting procedures MUST be followed EXACTLY for PROPER ADHESION and to prevent fish eyes.**

1. To remove any mold release contaminants, clean the back of the part first. Using 2 new clean rags, saturate the first rag with plastic prep cleaner\* and begin cleaning. Then use the second rag to remove the prep cleaner. Continuously fold both rags to their clean sides during the process. Use 3 sets of new rags throughout the process. This prevents mold release contaminants from transferring to the painted surface.
2. Repeat step one on the front of the part.
3. Rinse the part with water. Apply a generous amount of Ajax® or sand fix\* to a red scuff pad\* (3M Scotch Brite Brand) and scrub the surface to be painted THOROUGHLY (especially where the 2-sided tape is installed, on the back side of the part, and all the hard to reach areas). Then rinse with water and dry. The scrubbed surface should be dull. If any shiny spots show, repeat the process on those areas.
4. Using another set of clean new rags, again clean the surface to be painted with plastic prep cleaner.
5. Spray the surface to be painted with adhesion promoter\* including the areas where the 2-sided tape is installed (follow the instructions on the can for application and drying time).
6. Apply 3 to 4 coats of urethane primer\* with flex additive\* (follow the instructions on the can for application and drying time).
7. Wet sand primer with 600 grit sandpaper. Be careful not to sand through the primer. If you do, you MUST clean those areas with plastic prep cleaner, apply adhesion promoter and prime. Once the primer has dried, wet sand the areas that were touched up. Your surface is now ready for paint.

\* These items can be purchased at any auto body supply store.

| PART #4322 |                          |             |
|------------|--------------------------|-------------|
| QTY        | DESCRIPTION              | HARDWARE #  |
| 1          | ROLL OF 3-M 2-SIDED TAPE | VHB-202     |
| 4          | PHILLIPS SCREWS          | 10947-01704 |



## PART # 4322

### 05-06 MUSTANG OPTIONAL SCREW MOUNTING TEMPLATE FOR HEADLIGHT EXTENSIONS

**Optional screw mounts:** These headlight extensions have an optional screw mounting point. Use the template provided on this page to drill the two 1/4" holes in each fender. Flip the template over for the other side. After the extensions have been painted, install the 3m, 2-sided tape along the guidelines 1/8" from the outer edge **as shown in fig. E&F**. Only peel the red backing from the 3M 2-sided tape that follows the fender. Then install the headlight extension by aligning it with the hood in the corner first, then down the fender. At this point the fender will need to be removed in order to install the screws (be very careful not to bump the headlight extension causing it to lose its alignment). Once the screws have been installed then reinstall the fender and remove all of the red backing. Finish installing the tape across the bumper, and up along side the headlight. Press the edges down firmly and reinstall the factory bolt.

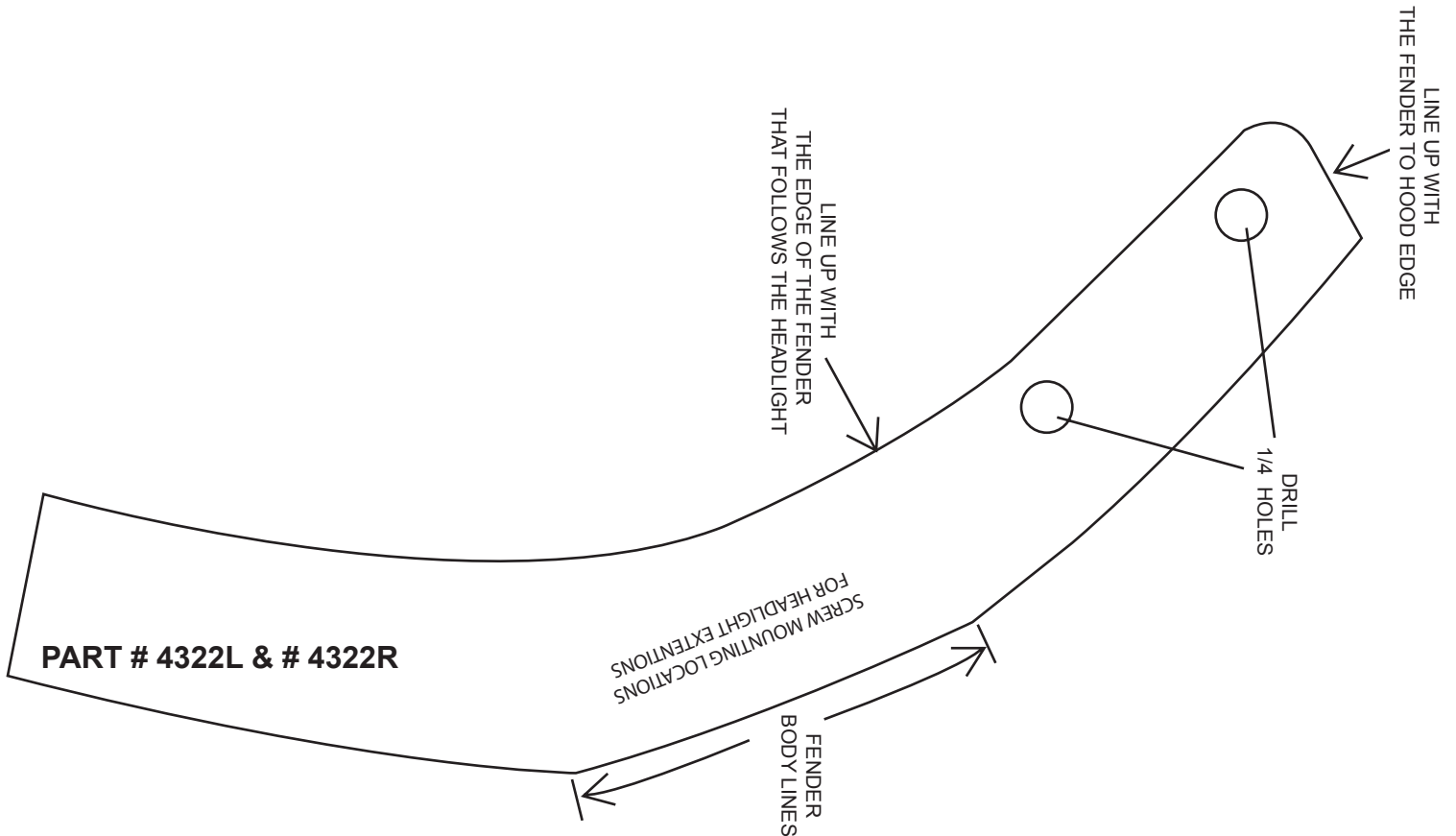

### 05-06 MUSTANG GRILLE EXTENSION CUTOUT FOR GT MODELS

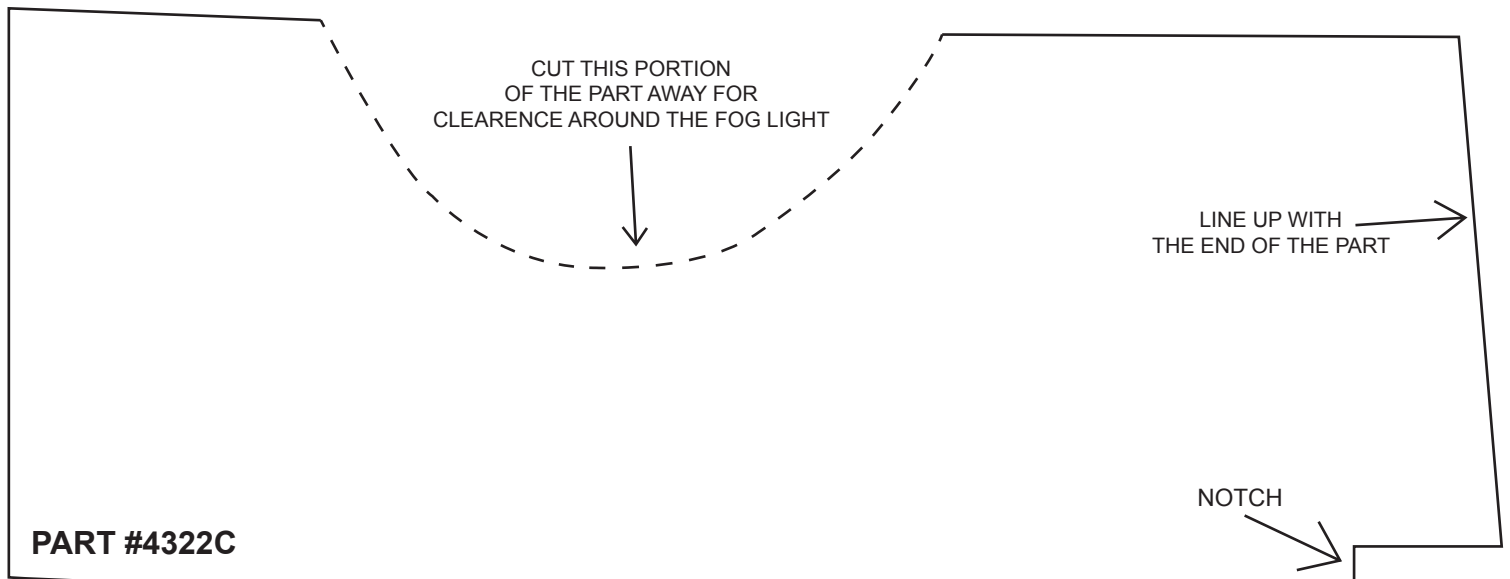

Fig. A

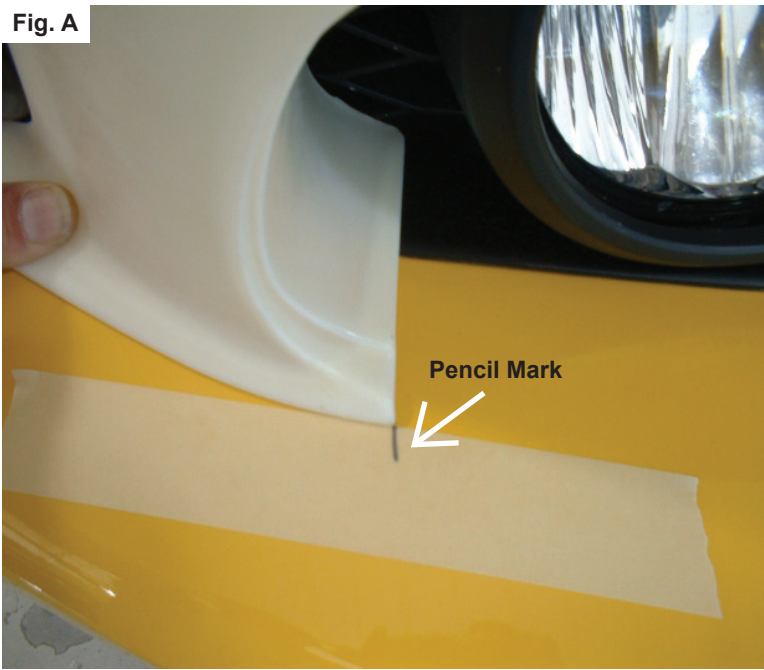

Fig. B

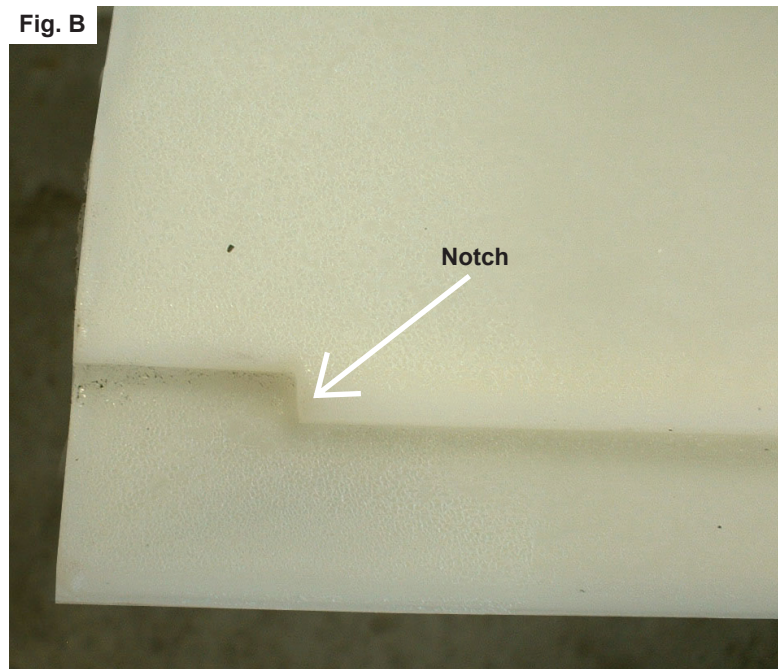

Fig. C

GRILLE EXTENTION



Fig. D

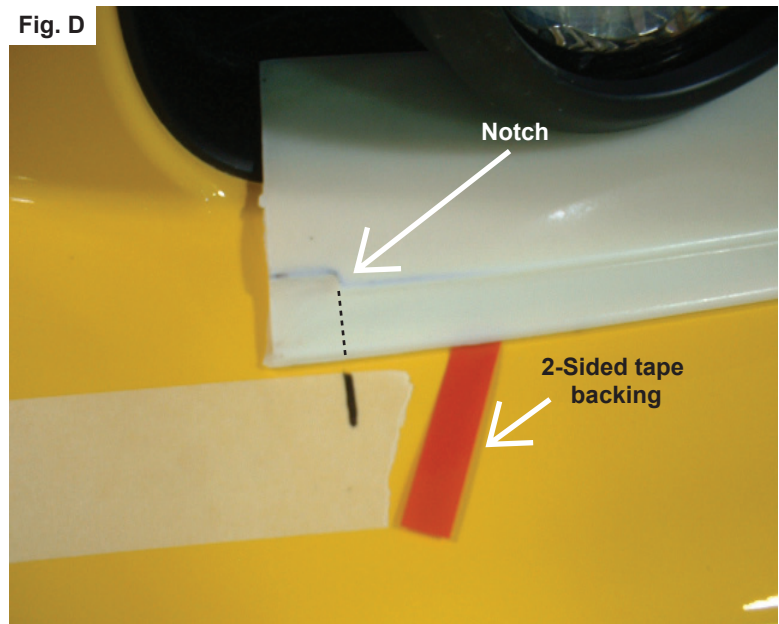

Fig. E

HEADLIGHT EXTENTION

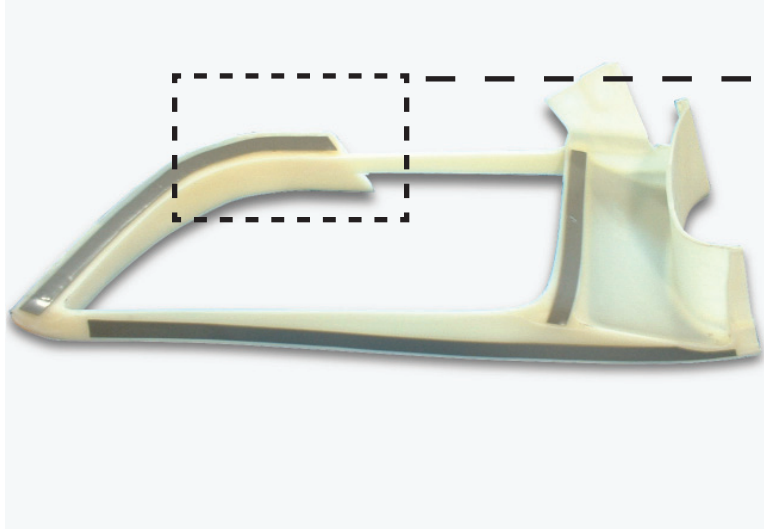
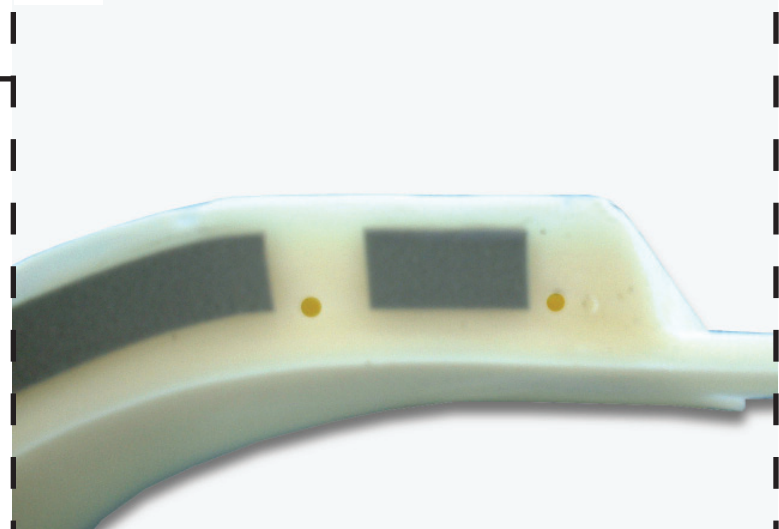

Fig. F

OPTIONAL SCREW MOUNTS



## PART #2230 05-08 MUSTANG PEDESTAL WING

**Notice: Pre-fit before painting. Install new, unpainted parts according to these instructions. Then remove parts, paint them and re-install. Painted or Altered Parts are Non-Refundable.**

**DO NOT** fill in vent holes on the underside of the wing.  
**DO NOT** blow air into vent holes, it will damage the part.

The flat washers **MUST** be used in conjunction with the bolts when attaching the wing. This pedestal wing can be installed by itself as a factory replacement wing or along with part # 4325 rear extensions.

**Installation as a factory replacement wing:** Remove the factory wing. Assemble the pedestals onto the wing as shown in fig. A. Mount the wing along with the pedestal gaskets to the trunk with one bolt in each side. (thread the bolt through the rear hole of the trunk and into the rear thread of the pedestal). Tape the gasket to the trunk as shown in fig. B, then remove the bolts and the wing from the trunk. This gasket is now your template for drilling the other hole for mounting the wing as shown in fig. C. Once the hole has been drilled install the wing with the bolts and washers to the trunk.

Fig. A



Fig. B



Fig. C

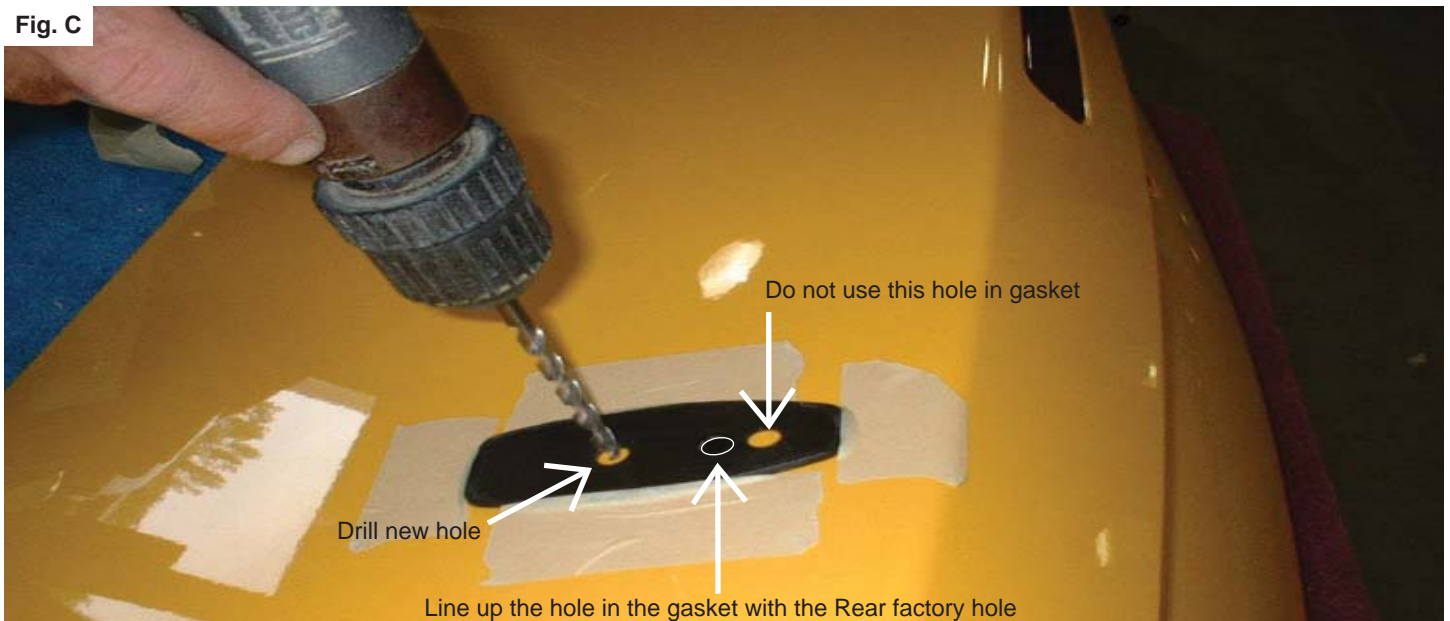

**Installation along with part # 4325 rear extensions:** Remove the factory wing. Assemble the pedestals onto the wing **as shown in fig. A**. Mount the wing along with the pedestal gaskets to the trunk with one bolt in each side. (thread the bolt through the front hole of the trunk and into the rear thread of the pedestal). Tape the gasket to the trunk **as shown in fig. B**, then remove the bolts and the wing from the trunk. This gasket is now your template for drilling the other hole for mounting the wing **as shown in fig. D**. Use the long studs to mount the wing in the new drilled holes.

Fig. A



Fig. B



Fig. D

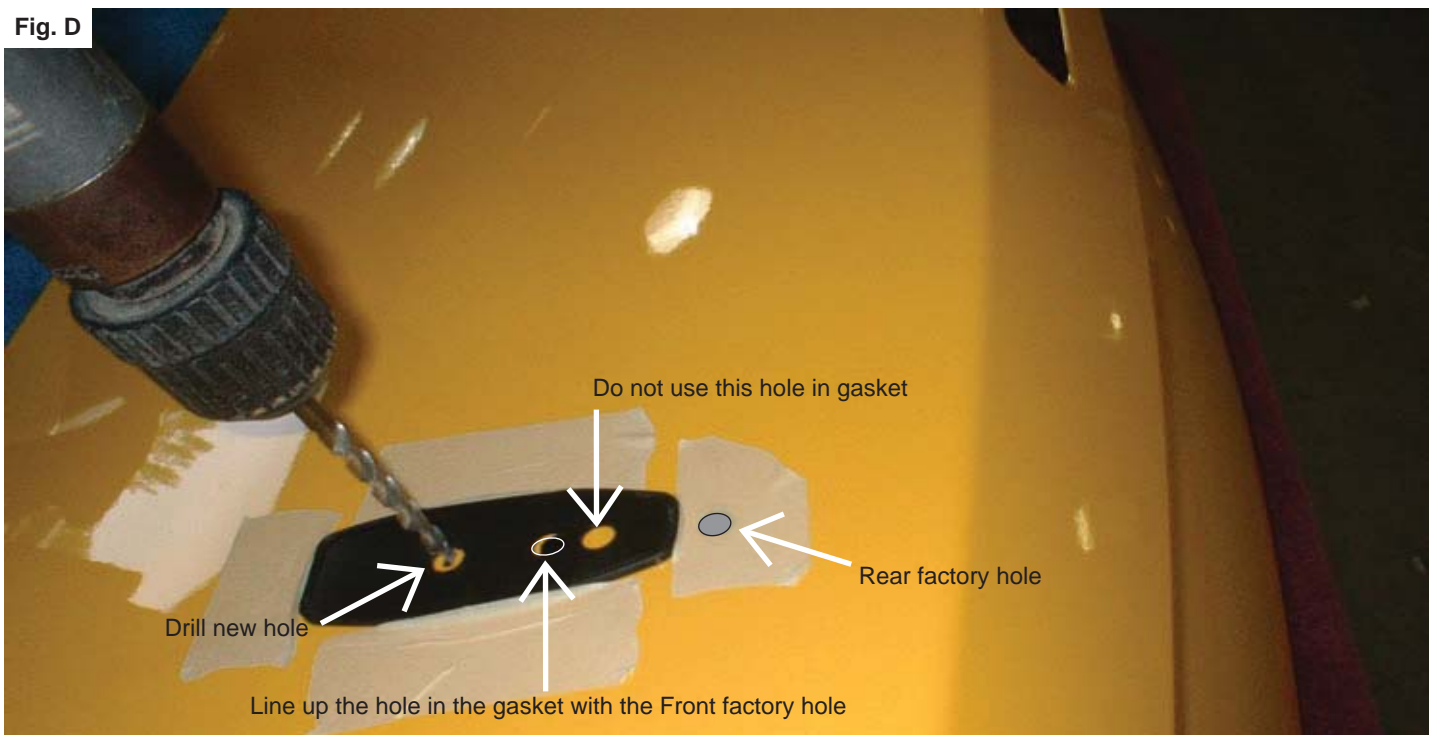

| PART #2230 |                                      |               |
|------------|--------------------------------------|---------------|
| QTY        | DESCRIPTION                          | HARDWARE #    |
| 2          | PEDESTALS W/GASKET & HARDWARE PACKET | D1ZZ6344210HD |
| 4          | HEX BOLTS                            | 13003         |
| 4          | WASHERS                              | 33004         |



## PART #4325

### 05-06 MUSTANG REAR EXTENSIONS

**Notice:** Prefit Before Painting. Install new, unpainted parts according to these instructions. Then remove parts, paint them and re-install.

#### **Painted or Altered Parts are Non-Refundable**

**The surface that is in contact with the 3M 2-sided tape must be cleaned with isopropyl alcohol & the temperature must be a minimum of 75 degrees F, before applying . Allow the 2-sided tape to dry 24 hours before driving.**

**Pre-fitting the trunk and quarter extensions:** If you have a factory trunk wing, it will need to be removed. This trunk extension will cover the holes that are closest to the back of the trunk. If part # 2230 pedestal wing is being installed along with these extensions then mount it according to its instructions in place before proceeding. Hold the trunk extension in place and check the alignment from the left to the right. Remove the trunk extension and hold in place the quarter extensions, check the alignment with the quarter panel and the rear bumper.

**Step 1, installing the trunk extension:** Included in the hardware packet is a roll of 3M 2-sided tape. After the trunk extension has been painted, install the 3m 2sided tape along the guidelines 1/8" away from the outer edge **as shown in fig. A**. Peel and fold about 2" of the red backing from the ends of each piece of tape, then place the trunk extension on the trunk so that the red backing is exposed and can be pulled (this will allow you to get the best alignment of the part). Pull the backing slowly. After all the backing is removed, firmly press the edges of the extension to securely adhere the tape.

**Step 2, installing the quarter extensions:** Included in the hardware packet is a roll of 3M 2-sided tape. After the quarter extensions have been painted, install the 3m 2sided tape along the guidelines 1/8" away from the outer edge **as shown in fig. B**. Peel and fold about 2" of the red backing from each piece of tape, then place the quarter extension on the quarter panel so that the red backing is exposed and can be pulled (this will allow you to get the best alignment of the part). Pull the backing slowly. After all the backing is removed, firmly press the edges of the extension to securely adhere the tape.

| PART #4325 |                          |            |
|------------|--------------------------|------------|
| QTY        | DESCRIPTION              | HARDWARE # |
| 1          | ROLL OF 3-M 2-SIDED TAPE | VHB-230    |



Fig. A



Fig. B



## PAINTING INSTRUCTIONS

**VERY IMPORTANT: The following painting procedures MUST be followed EXACTLY for PROPER ADHESION and to prevent fish eyes.**

1. To remove any mold release contaminants, clean the back of the part first. Using 2 new clean rags, saturate the first rag with plastic prep cleaner\* and begin cleaning. Then use the second rag to remove the prep cleaner. Continuously fold both rags to their clean sides during the process. Use 3 sets of new rags throughout the process. This prevents mold release contaminants from transferring to the painted surface.
2. Repeat step one on the front of the part.
3. Rinse the part with water. Apply a generous amount of Ajax® or sand fix\* to a red scuff pad\* (3M Scotch Brite Brand) and scrub the surface to be painted THOROUGHLY (especially where the 2-sided tape is installed, on the back side of the part, and all the hard to reach areas). Then rinse with water and dry. The scrubbed surface should be dull. If any shiny spots show, repeat the process on those areas.
4. Using another set of clean new rags, again clean the surface to be painted with plastic prep cleaner.
5. Spray the surface to be painted with adhesion promoter\* including the areas where the 2-sided tape is installed (follow the instructions on the can for application and drying time).
6. Apply 3 to 4 coats of urethane primer\* with flex additive\* (follow the instructions on the can for application and drying time).
7. Wet sand primer with 600 grit sandpaper. Be careful not to sand through the primer. If you do, you MUST clean those areas with plastic prep cleaner, apply adhesion promoter and prime. Once the primer has dried, wet sand the areas that were touched up. Your surface is now ready for paint.

\* These items can be purchased at any auto body supply store.





## Warranty

All retail parts carry a 90-day warranty from the date of purchase. This warranty covers defects in materials or workmanship, and does not include (i) normal wear and tear, environmental conditions, improper installation; (ii) road hazards, misuse, abuse, neglect, accidents, collision, fire, theft, freezing, vandalism, riot, explosion, or objects striking the vehicle; (iii) misusing the vehicle, such as driving over curbs, overloading, racing, or using the vehicle as a stationary power source; (iv) altering, disassembling or modifying the parts; (v) defects caused or induced by failures, breakdowns, or damage by other parts, components or the vehicle; (vi) subjecting the parts to excessive moisture or water or any motor vehicle fluids (e.g.: oil, anti-freeze, battery acid, brake fluid, etc.); (vii) acts of God, natural disasters and other similar causes beyond the reasonable control of MRT-VISUS; or (viii) application of chemicals that affect the parts. This Limited Warranty does not cover surface deterioration of paint, trim, and appearance items that result from use and/or exposure to the elements, such as stone chips, scratches, bird droppings, lightning, hail, windstorm, dings, dents, earthquake, road salt, tree sap, water or flood.

**MRT-MRT-VISUS SHALL NOT BE LIABLE TO REIMBURSE CUSTOMER/DEALER FOR INCIDENTAL OR CONSEQUENTIAL DAMAGES RESULTING FROM THE INSTALLATION OR USE OF ANY PRODUCT SOLD THROUGH THIS CATALOG OR ARISING OUT OF ANY BREACH OF WARRANTY, EXCEPT AS MAY BE STATED IN THIS CATALOG, MRT-VISUS DISCLAIMS ALL EXPRESS AND IMPLIED WARRANTIES, INCLUDING THE WARRANTIES OF MERCHANTABILITY AND FITNESS FOR A PARTICULAR PURPOSE. IN NO EVENT SHALL MRT-VISUS'S LIABILITY EXCEED THE PRICE PAID BY CUSTOMER/DEALER FOR PRODUCTS SOLD REGARDLESS IF MRT-VISUS HAS BEEN ADVISED IN ADVANCE OF ANY POTENTIAL PROBLEM OR IF A CLAIM IS BASED ON CONTRACT, TORT, STRICT LIABILITY. PRODUCT LIABILITY OR OTHERWISE. SOME STATES DONOTALLOW THE EXCLUSION OR LIMITATION OF IMPLIED WARRANTIES OR THEIR DURATION, OR LIABILITY FOR INCIDENTAL OR CONSEQUENTIAL DAMAGES, SO THE ABOVE EXCLUSIONS OR LIMITATIONS MAY NOT APPLY.**



## MRT Visus 05+ Louver Assembly

 2 Corner Clips

 2 Latch Pads

 2 Hinge Pads

 1 Set of Latches and Feet



 Alcohol Swabs

 GAP1 Adhesion Promoter

 3M Adhesion Promoter

 2 Hinge Washers

 2 - 22" Foam Strips

 4 - #8-32 Nuts

 1 Template



### Tools & Materials Required

1. Phillips Screwdriver
2. Pen
3. Masking Tape
4. Scissors
5. 11/32 Wrench
6. Tape Measure

### Louver Install

1. Clean Window with Isopropyl Alcohol, place a 5" piece of masking tape on center top edge of glass mark center of glass on tape with a pen
2. Cut Out Template. Center and tape it on upper part of glass.
3. Apply Gap1 Adhesion promoter in upper pad areas close the packet to slow evaporation.
4. Peel the tape from the hinge pads and mount in place
5. Burnish with the back end of a screw driver
6. Attach the Hinges to the Louver at the top about 9/16" from the bottom of the hinge pads. Put washer plates over hinges and apply the nuts loosely then align the louvers so they fit aligned to the glass at the top and centered in the window.
7. Tighten the hinge nuts with 11/32" wrench.
8. Secure the latch pads on the lower latch clips lower the louver to check pads locations while pressing on the lower center to hold the feet down then use Masking tape to frame the area and apply Gap1 promoter to the area, and stick in place.
9. Slip Corner Clips beneath the louver's top corners touch to glass to secure when in position.

Place corner clips on the installed louver at provide spots at top. Lower louver to allow clips to adhere to the glass And apply downward pressure on clip and louver.

Apply 3M Adhesion Promoter to underside of the out side channels on the louver and then apply the 22" Foam Strips between the # 2 and 5 louvers.

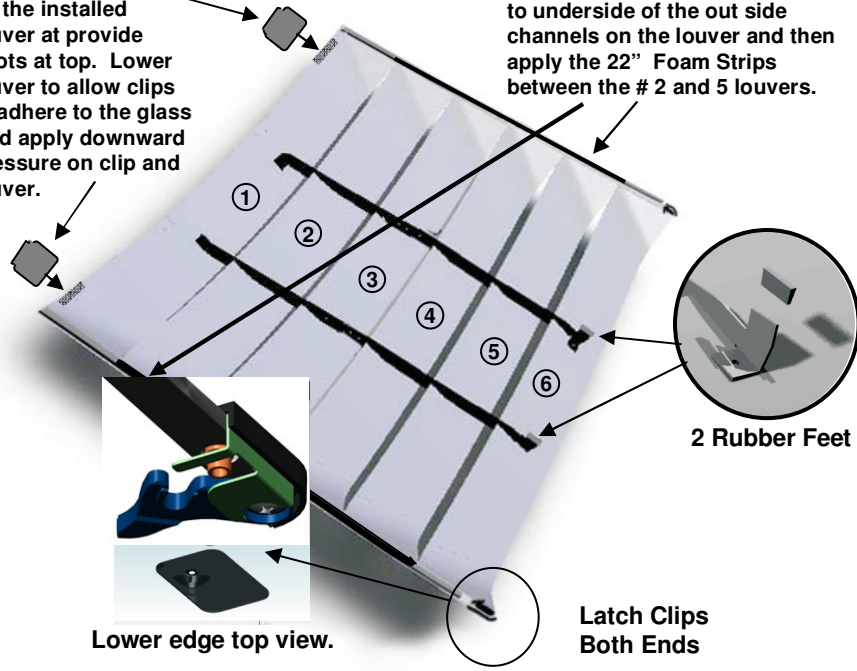

Lower edge top view.

Latch Clips Both Ends

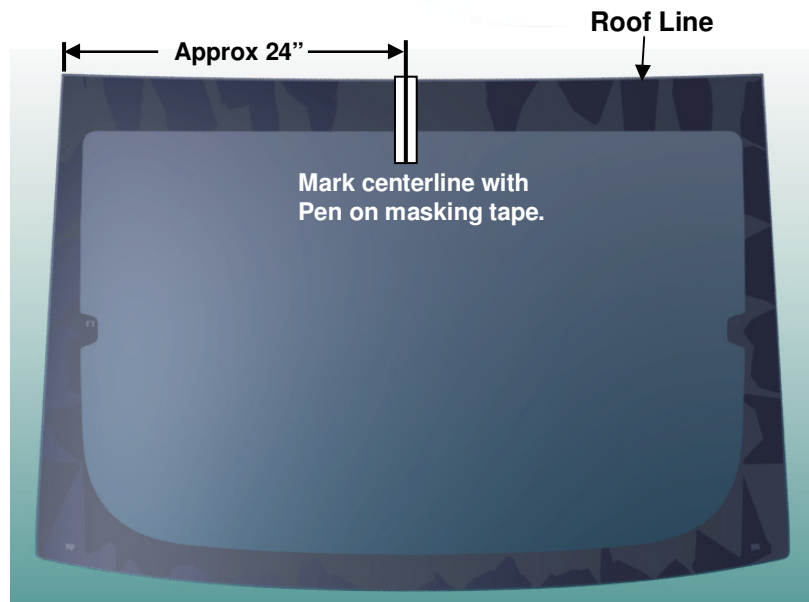

Placement of template on glass centerline for hinge plates location.

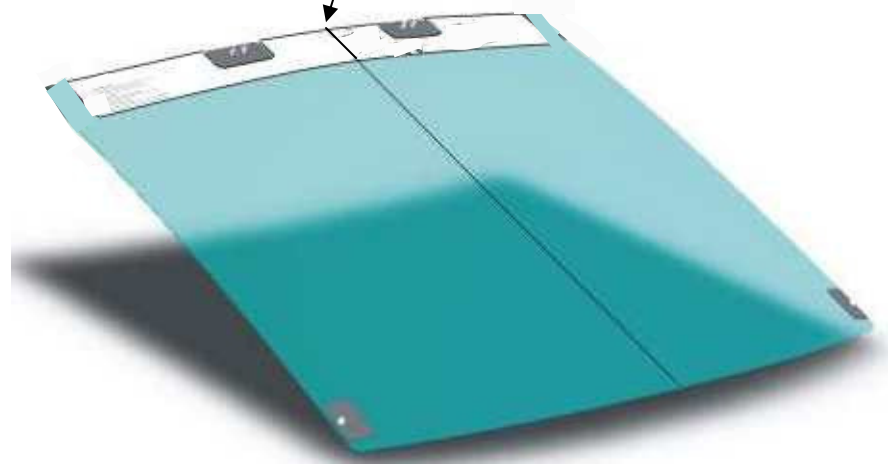

Hinge shown without louver

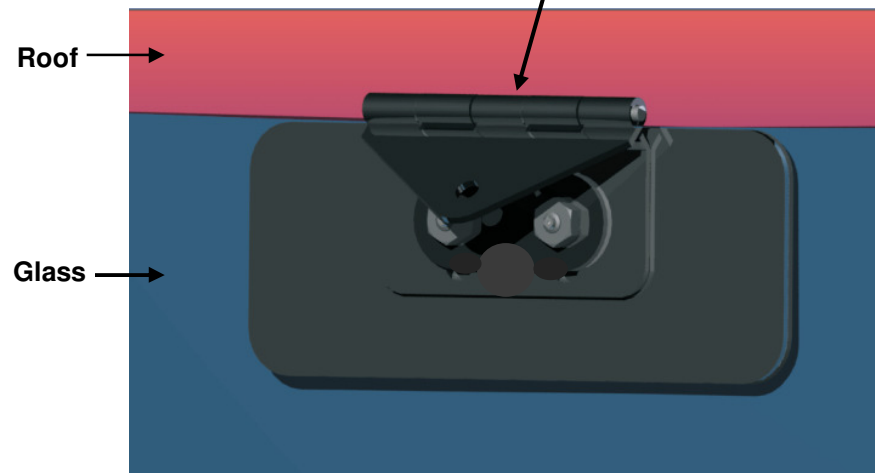

With louver raised up mount louver with hinge spacing shown above.

# PART #4319 05-08 MUSTANG B9 HOOD SCOOP

CUT OUT TEMPLATE ALONG THE BLACK LINE

CUT OUT TEMPLATE ALONG THE BLACK LINE

FRONT

## INSTALLING THE B9 HOOD SCOOP ALONG WITH A FACTORY HOOD

Drill a 1/4" hole here

**Notice:** Prefit Before Painting. Install new, unpainted parts according to these instructions. Then remove parts, paint them and re-install.  
Painted or Altered Parts are Non-Refundable  
The surface that is in contact with the 3M 2-sided tape must be cleaned with isopropyl alcohol & the temperature must be a minimum of 75 degrees F, before applying . Allow the 2-sided tape to dry 24 hours before driving.

**Pre-fitting the hood scoop:** If you are attaching this scoop to a factory hood, then use this template to locate where the holes are drilled. Measure from the left to the right side of the hood to locate the center of the factory hood. Line up the template with the center line of the hood, and tape in place. Drill the 1/4" holes indicated and install the scoop with the black screws provided in the hardware packet. After the scoop has been painted, apply the 2-sided tape 1/8" away from the outer edge along the rear and side edge of the scoop. Peel and fold about 2" of the red backing from the ends of each piece of tape, then place the scoop on the hood so that the red backing is exposed and can be pulled (this will allow you to get the best alignment of the scoop). After the backing is removed, install the 6 black screws and firmly press the edges of the scoop to securely adhere the tape.

### PAINTING INSTRUCTIONS

**VERY IMPORTANT:** The following painting procedures **MUST** be followed **EXACTLY** for **PROPER ADHESION** and to prevent fish eyes.

1. To remove any mold release contaminants, clean the back of the part first. Using 2 new clean rags, saturate the first rag with plastic prep cleaner\* and begin cleaning. Then use the second rag to remove the prep cleaner. Continuously fold both rags to their clean sides during the process. Use 3 sets of new rags throughout the process. This prevents mold release contaminants from transferring to the painted surface.
2. Repeat step one on the front of the part.
3. Rinse the part with water. Apply a generous amount of Ajax® or sand fix\* to a red scuff pad\* (3M Scotch Brite Brand) and scrub the surface to be painted THOROUGHLY (especially where the 2-sided tape is installed, on the back side of the part, and all the hard to reach areas). Then rinse with water and dry. The scrubbed surface should be dull. If any shiny spots show, repeat the process on those areas.
4. Using another set of clean new rags, again clean the surface to be painted with plastic prep cleaner.
5. Spray the surface to be painted with adhesion promoter\* including the areas where the 2-sided tape is installed (follow the instructions on the can for application and drying time).
6. Apply 3 to 4 coats of urethane primer\* with flex additive\* (follow the instructions on the can for application and drying time).
7. Wet sand primer with 600 grit sandpaper. Be careful not to sand through the primer. If you do, you **MUST** clean those areas with plastic prep cleaner, apply adhesion promoter and prime. Once the primer has dried, wet sand the areas that were touched up. Your surface is now ready for paint.

\* These items can be purchased at any auto body supply store.

Drill a 1/4" hole here



Drill a 1/4" hole here



| PART #4319 |                          |             |
|------------|--------------------------|-------------|
| QTY        | DESCRIPTION              | HARDWARE #  |
| 6          | PHILLIPS SCREWS          | 32144       |
| 1          | ROLL OF 3-M 2-SIDED TAPE | VHB-120     |
| 2          | PHILLIPS SCREWS          | 10947-01704 |
| 4          | PHILLIPS SCREWS          | WE-2623     |
| 2          | WASHERS                  | 91090A107   |

CENTER LINE OF HOOD

CENTER LINE OF HOOD

## INSTALLING THE B9 HOOD SCOOP ALONG WITH PART # 1175 VINTAGE HOOD

Drill a 1/4" hole here

**Notice:** Prefit Before Painting. Install new, unpainted parts according to these instructions. Then remove parts, paint them and re-install.  
Painted or Altered Parts are Non-Refundable  
The surface that is in contact with the 3M 2-sided tape must be cleaned with isopropyl alcohol & the temperature must be a minimum of 75 degrees F, before applying . Allow the 2-sided tape to dry 24 hours before driving.  
**Do not use this template to locate the holes for mounting the scoop.**

Use the provisions on the underside of the hood for attaching the scoop. Drill the 3 dot locations on each side of the hood with a 1/4" drill bit **as shown in fig. A**. After the scoop has been painted, apply the 2-sided tape 1/8" away from the outer edge along the rear and side edges of the scoop. Peel and fold about 2" of the red backing from the ends of each piece of tape, then place the scoop on the hood so that the red backing is exposed and can be pulled (this will allow you to get the best alignment of the scoop). After the backing is removed, install the 6 silver screws and firmly press the edges of the scoop to securely adhere the tape.

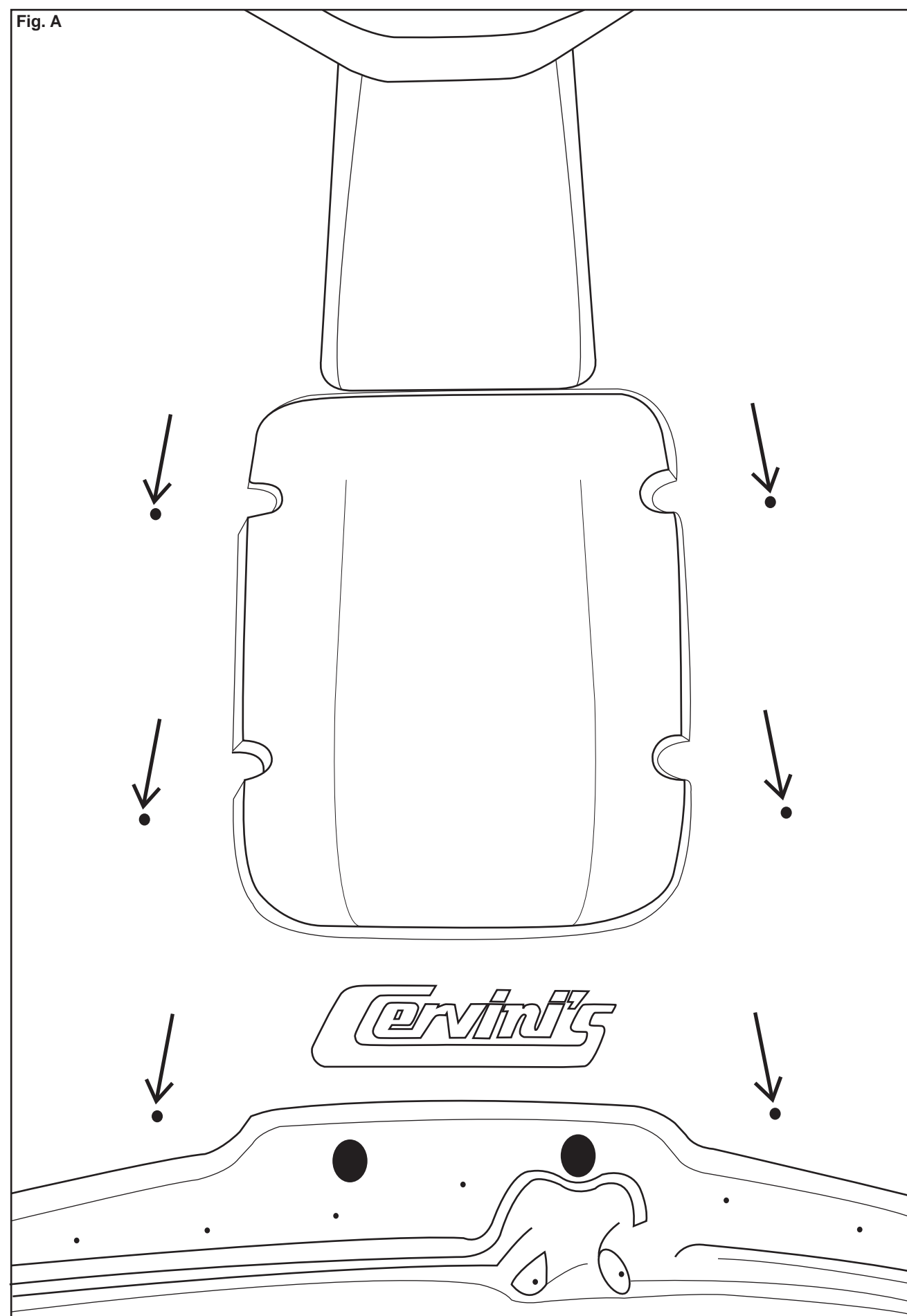

Drill a 1/4" hole here



Drill a 1/4" hole here



3656 N. MILL ROAD, VINELAND, NEW JERSEY 08360 • TECH INFO 1-800-488-6057

BACK

Place this line even with the back edge of the factory stock hood